

MIDIS

CONNECTION INSTRUCTIONS FOR FACEPLATES



RECOMMENDATIONS

This documentation is intended for professionals trained and experienced in the elevator industry.

Consequently, when working on an elevator to install **ANEP** equipment, the safety rules specific to the profession must be respected.

- Use of «Personal Protective Equipment».
- Consignment of the installation before making any electrical connections.
- To put oneself in safety before intervening in the shaft.
- etc.

Before handling any anep equipment, make sure that it has been de-energized beforehand.

On all «ANEP BOX» (TA, TA+, TX, TX+, ...)



**It is essential to connect
all the peripherals
BEFORE
connecting the telephone line
and the power supply:**

- Car alarm button (NO or NC in dry contact)
- MIDIS requires a 230/12V secured and controlled power supply, such as ANEP ALIM-CONTROL 2
- Emergency **lighting on permanently** with the presence of the power supply

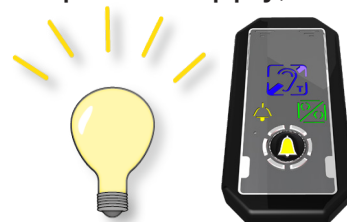

Electrical equipment must be compulsorily recycled according to the Directive n°2012/19/UE of 04/07/12 on waste electrical and electronic equipment (WEEE).

SUMMARY

Summary	page 3
Cables supplied with MIDIS / MIDIS-BP	page 4
MIDIS connection with BP ALARM NO	page 5
MIDIS connection with BP ALARM NC	page 6
Explanation of double contact	page 7
MIDIS-BP connection with ALARM NO PO	page 8
Connection MIDIS-BP with BP ALARM NC	page 9
Notes	page 10
Warranty	page 11
After-sales service	page 12

WIRES SUPPLIED with MIDIS (WITHOUT BUTTON)

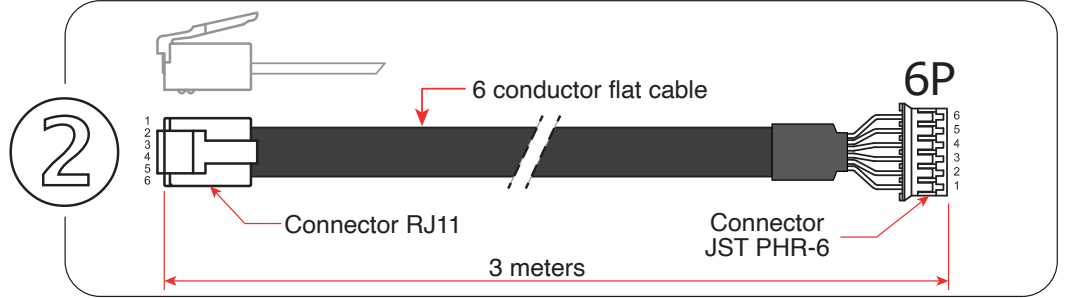
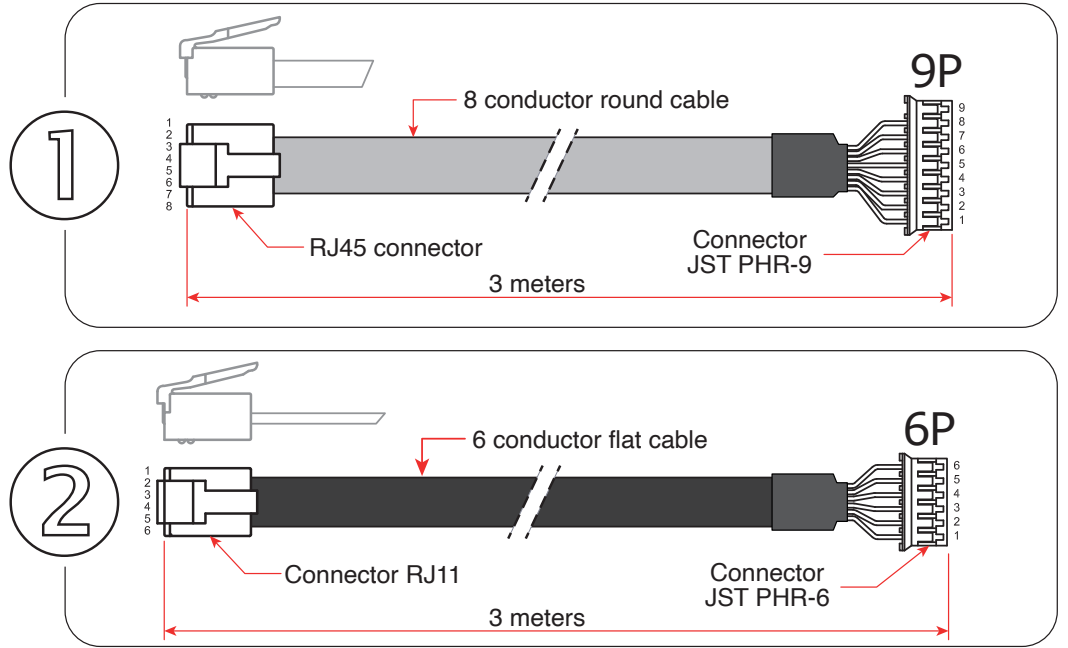
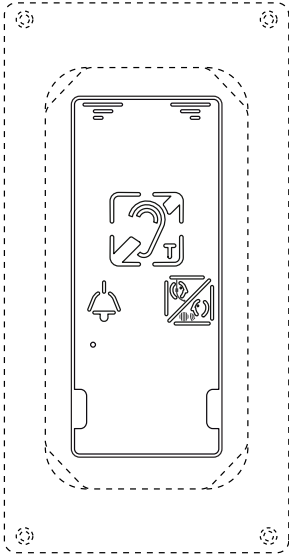

CABLES SUPPLIED with MIDIS-BP (PUSH BUTTON)

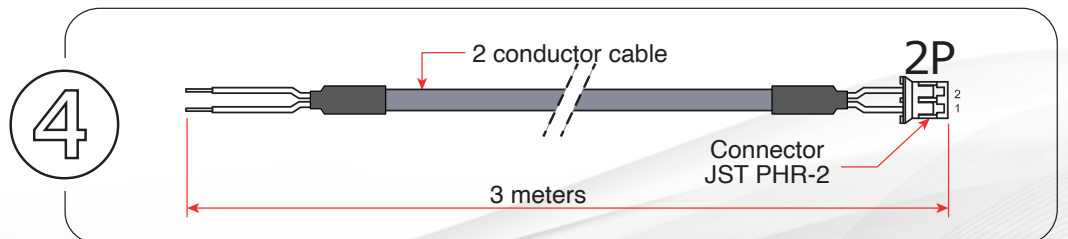
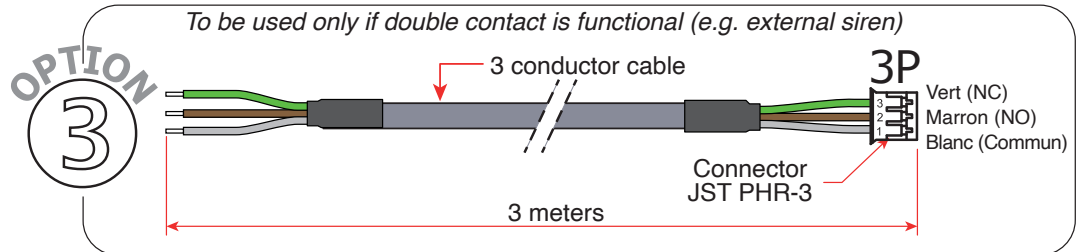
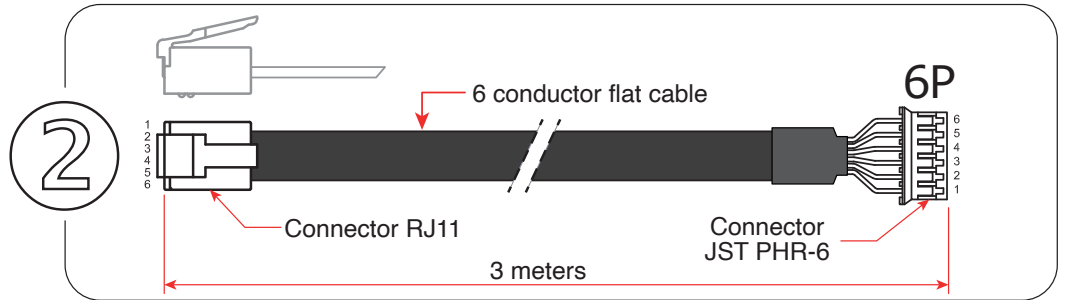
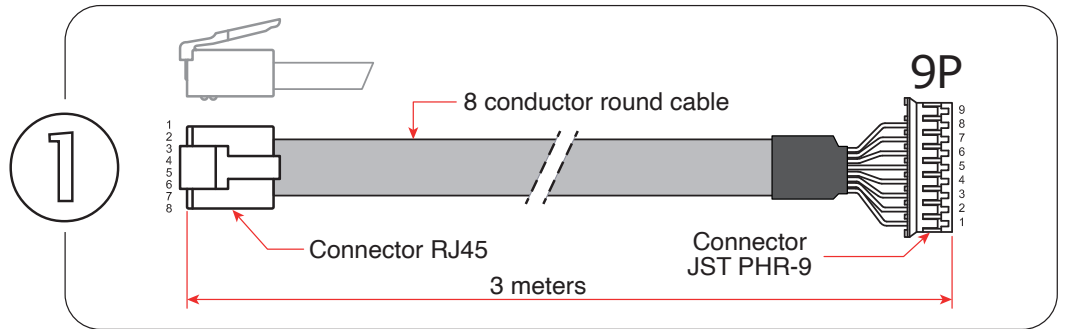
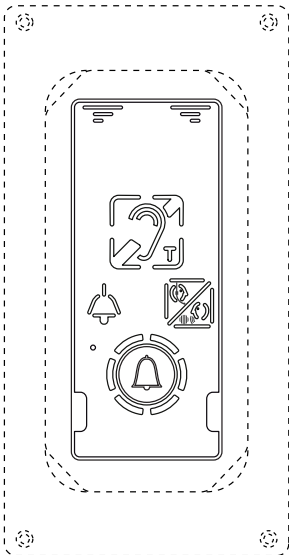

Phonie MIDIS (WITHOUT PB)



WIRING BUTTON CABIN ALARM



NO

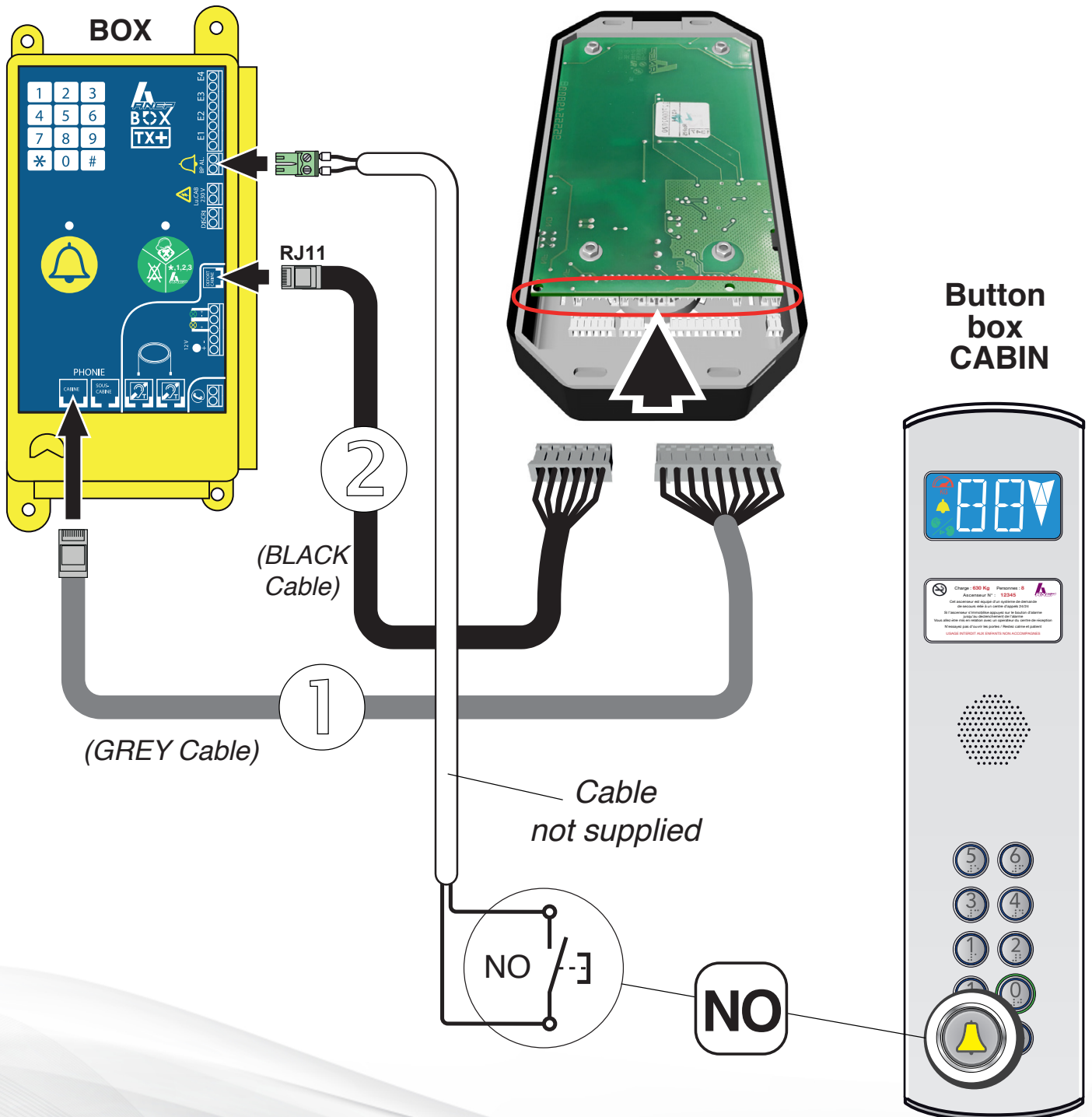

Phonie MIDIS (WITHOUT PB)



WIRING BUTTON CABIN ALARM



NC

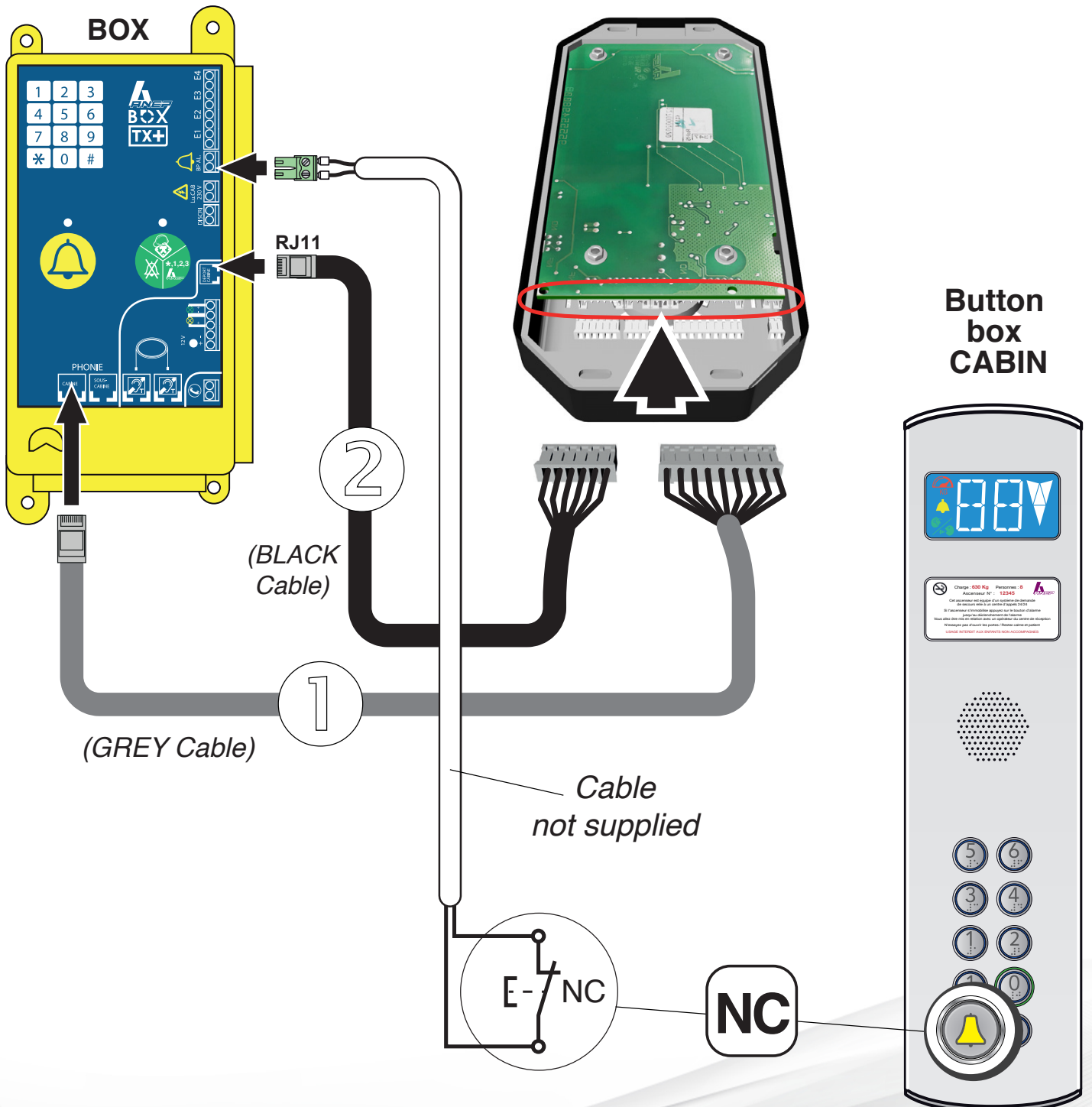

OPTION
3

SUPPLIED CABLE for DOUBLE CONTACT (if required) :

**DOUBLE CONTACT of the BUTTON
for EXTERNAL SIREN, REPORT etc ...**

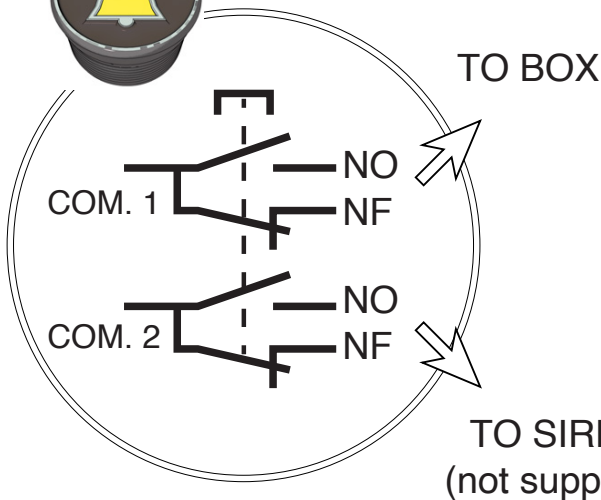
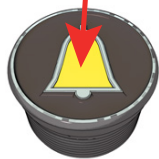

**DOUBLE CONTACT
(MIDIS-BP)**

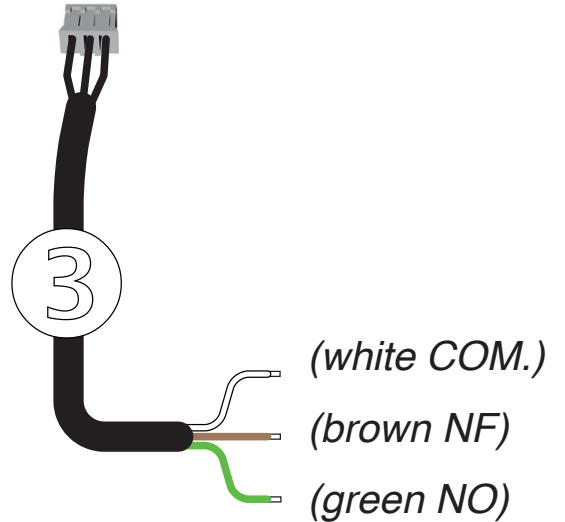

DOUBLE CONTACT CHARACTERISTICS :

- 12Vdc 2A maxi
- 24Vdc 1A maxi
- 42Vdc 0,5 A maxi
- 125Vdc 0,1 A maxi

Phonie MIDIS-BP (WITH PB)



WIRING BUTTON CABIN ALARM



NO

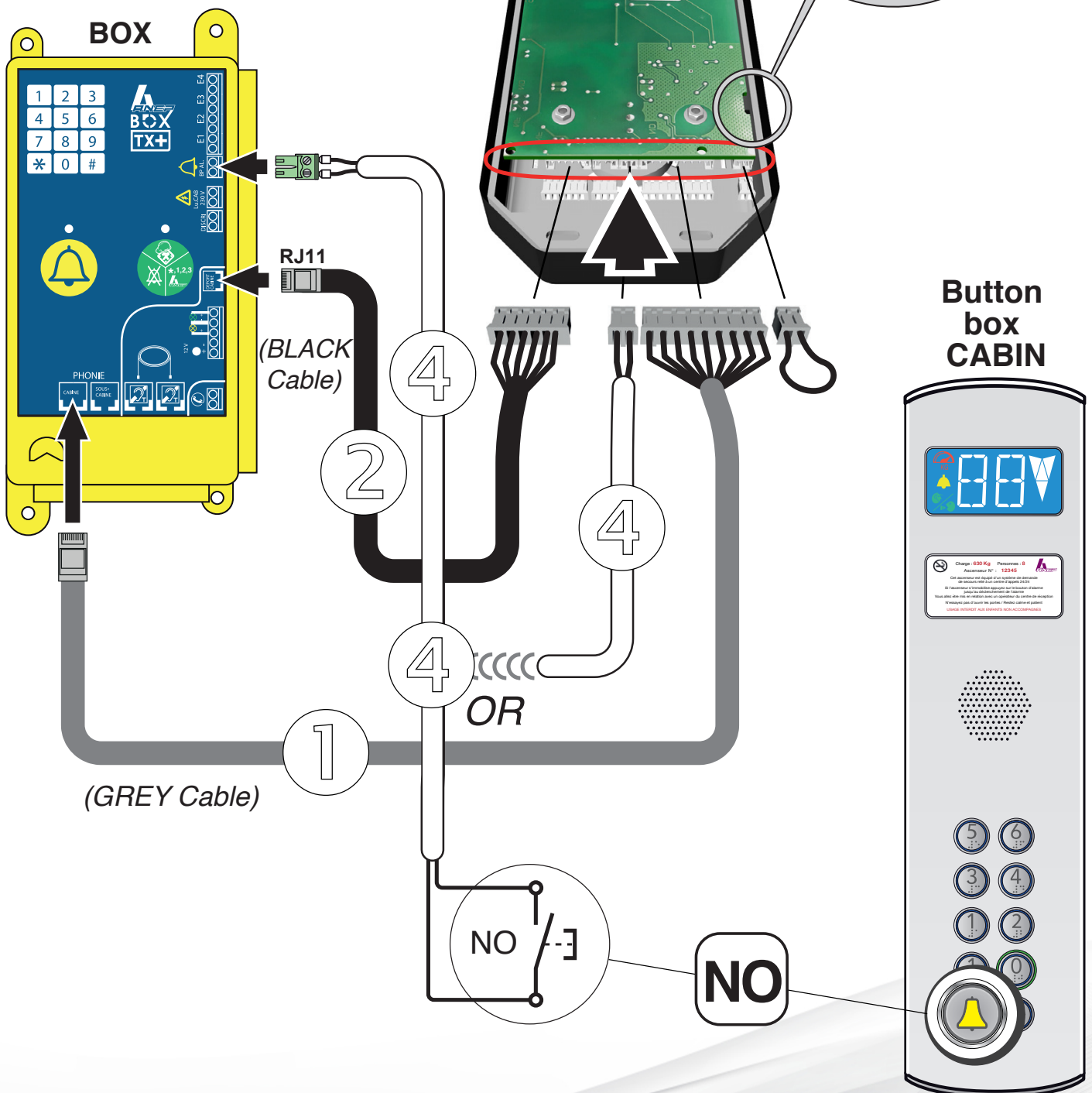
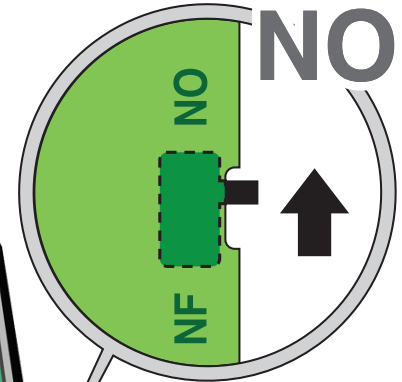

Phonie MIDIS-BP (WITH PB)



WIRING BUTTON CABIN ALARM



NC

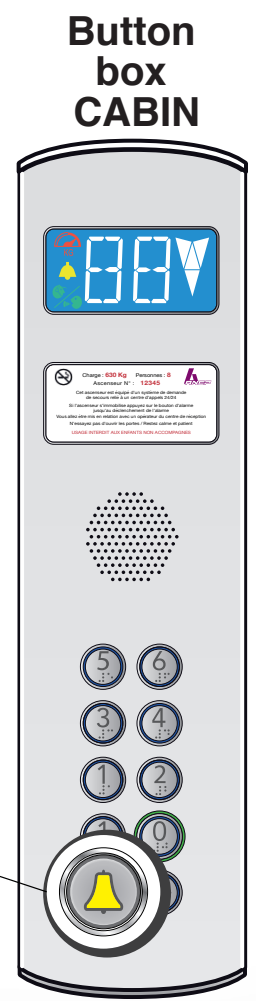
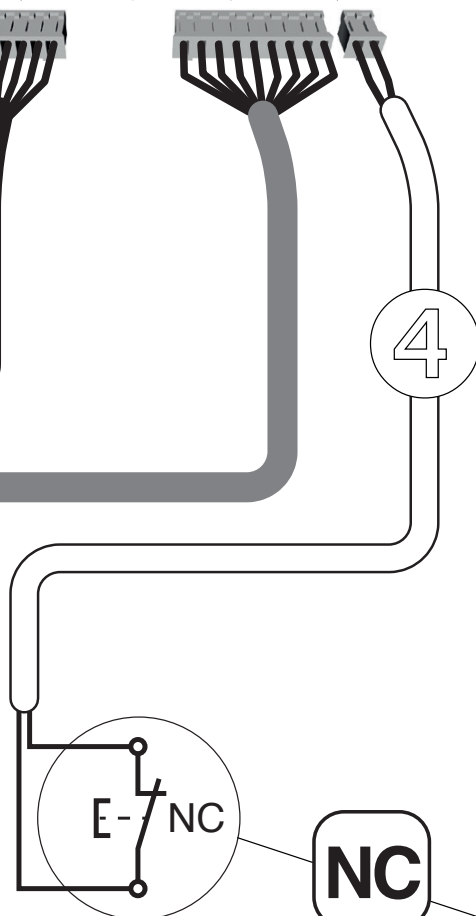
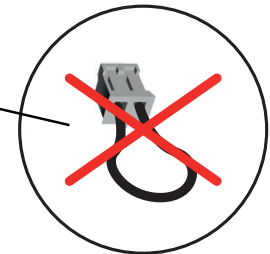
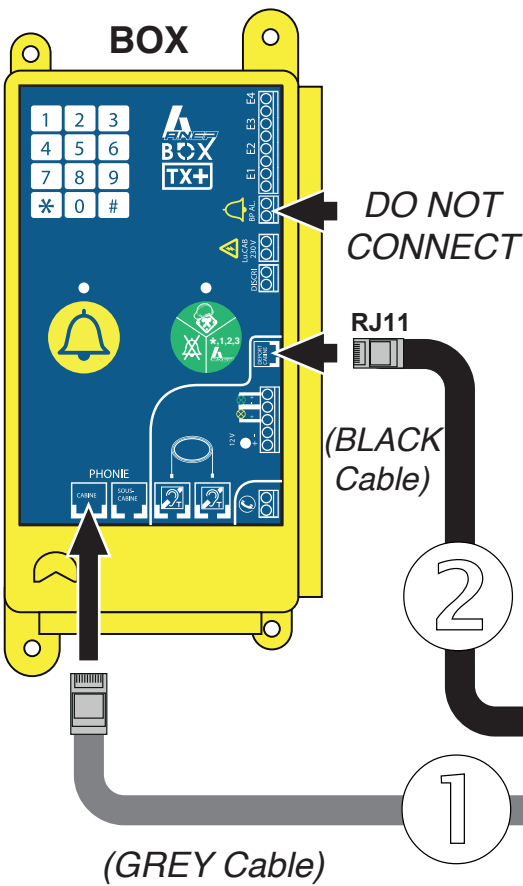
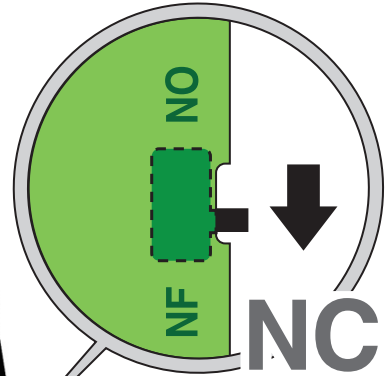

WARRANTY

NOTES

ANEP operates a continuous development process, and therefore ANEP reserves the right to make changes and improvements to any of the products described in this document without prior notice.

ANEP cannot be held responsible for any loss of data, as well as any special or incidental damages, resulting from improper implementation or use of the product.

The contents of this document are provided «as is». No warranty of any kind, expressed or implied, is made with respect to the accuracy, reliability or content of the document.

ANEP reserves the right to revise or withdraw this document at any time without notice.

WARRANTY

This product is guaranteed for **3 years** from the date of invoice, except for batteries which are guaranteed for **6 month**.

However, this warranty does not apply in case of:

- Use not in accordance with the instructions in this manual.
- Deterioration resulting from an external cause to the product (act of vandalism, fire, flood, storm vandalism, fire, flood, storm, power surge...).
- Installation by an unqualified installer not approved by ANEP.
- Modifications or repairs performed by entities not authorized by ANEP.
- Opening of the product by a person not authorized by ANEP.



IMPORTANT

Particular care and attention must be paid to the wiring and connection, in order to obtain the best sound results and optimal reliability of the product.

The equipment must be connected, installed and programmed according to the rules of the profession.

LE SERVICE APRÈS VENTE EST ASSURÉ PAR

SAVTEL

4 bis rue de Paris 94470 Boissy-Saint-Léger

Tél : 01 45 98 34 44



Site internet : www.anepstore.com