

# ANEP BOX TX+

REMOTE ELEVATOR ALARM OPERATION CONTROL

SCALABLE MULTI-LIFT INTERCOM AND VOICE SYSTEM

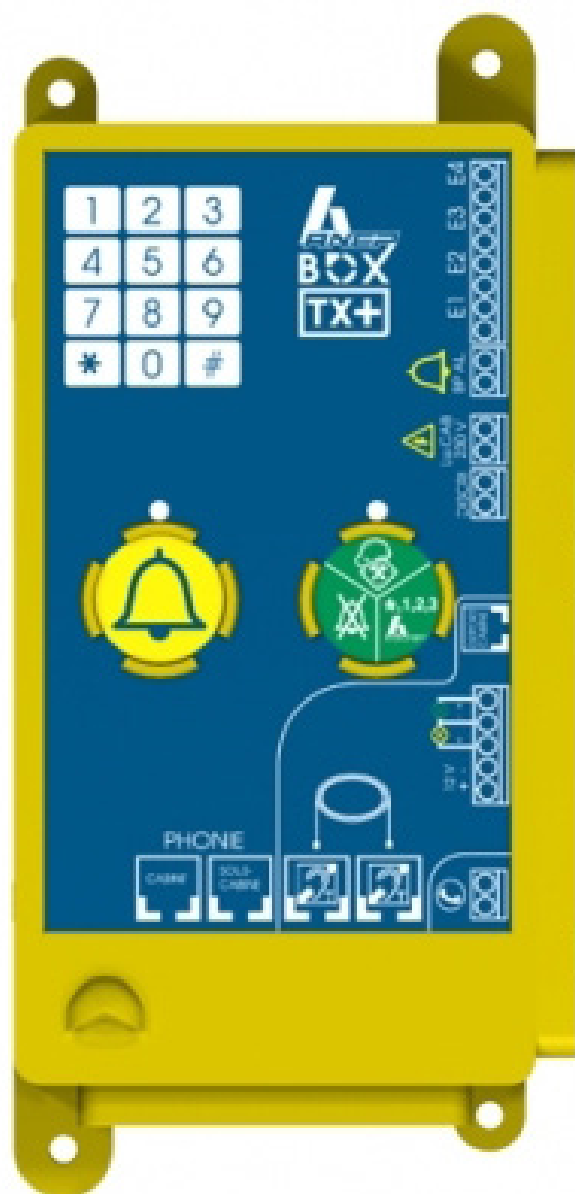

# 1 - RECOMMANDATIONS

This documentation is aimed at professionals who are trained and experienced in the lift industry.

## 1.1 - Installation / Commissioning

Consequently, when working on an elevator to install ANEP equipment, safety rules specific to the profession must be respected.

- Use of «**Personal Protective Equipment**».
- Switch off the system before making any electrical connections.
- **Make yourself safe before working in a shaft.**



Before handling anep equipment, make sure it is **DE-ENERGIZED**.

On all «ANEP BOX» equipment (TA, TA+, TX, TX+, ...)

**It is essential to connect all peripherals BEFORE connecting the telephone line :**

- Cabin alarm button (NO or NC **dry contact**)
- Cabin faceplate (MIDIS) or speaker and microphone (BA-mini-GHP)
- Under-cab audio (BOX-SC)
- ANEP **ALIM CONTROL-II** type 230 / 12V battery-backed and controlled power supply (if auditory magnetic loop and/or Yellow/Green LEDs)

## 1.2 - Pendant cable

We recommend that you fit the elevator with a shielded pendant cable to ensure excellent voice quality and avoid any disturbances that could lead to malfunctions.

Particular care must be taken to ensure that the telephone line is routed in such a way as not to degrade standard technical characteristics..

Check the wiring, especially if it connects multiple elevator machines.

- Type of cable, Cable routing (low/high current), Parasites (VMC, generators), etc ...



Electrical equipment must be recycled in accordance with Directive n°2012/19/EU of 7/04/2012 on waste electrical and electronic equipment (WEEE).

# SUMMARY

<b>1 - <u>RECOMMANDATIONS</u></b>	<b><u>Page 2</u></b>
1.1 - Installation / Commissioning	
1.2 - Pendant cable	
<b>2 - <u>GENERAL</u></b>	<b><u>Page 6</u></b>
2.1 - Technical data	
<b>3 - <u>BOX-TX+ CONNECTION</u></b>	<b><u>Page 7</u></b>
3.1 - Sensor connection	
3.2 - Connection of POSITION / OFFSET sensors [E3] and [E4]	
3.2.1 - Elevator with short floor	
3.3 - PO and PF sensor connection	
3.3.1 - Single-access elevator	
3.3.2 - Dual-access elevator	
3.4 - Programming for special cases	
3.4.1 - Elevator with fully manual doors	
3.4.2 - Elevator with mixed doors (swing and automatic)	
3.4.3 - Factory settings	
<b>4 - <u>YELLOW &amp; GREEN LED CONNECTION</u> (If MIDIS absent)</b>	<b><u>Page 13</u></b>
4.1 - Yellow & Green LED programming / EN81-28 2003 or 2022 standards	
<b>5 - <u>CABIN ALARM DISCRIMINATION</u></b>	<b><u>Page 15</u></b>
5.1 - Discrimination not validated	
5.2 - Internal discrimination	
5.3 - External Discrimination BOX-DISCRI / DISCRI input extension	
5.4 - Forced alarm	
<b>6 - <u>ADDRESSING AND PROGRAMMING THE TRANSMITTER NUMBER</u></b>	<b><u>Page16</u></b>
6.1 - Addressing Module number	

### **7.1 - Access to programming**

### **7.2 - Exit programming mode**

### **7.3 - Choice of telephone network**

7.3.1 - Standard mode

7.3.2 - Autocom mode

7.3.3 - GSM mode

### **7.4 - Number programming**

7.4.1 - Programming memory 101 (Main phone call)

7.4.2 - Programming a memory with a pause (autocom)

7.4.3 - Delete a number

### **7.5 - Memory allocation**

7.5.1 - Transfer method

7.5.2 - Single communication programming table.

7.5.3 - Dual call «mode configuration»

### **7.6 - Parameter validations and settings**

7.6.1 - Alarm button delay time

### **7.7 - Blocked person call acknowledgement (EN81-28) by #1**

### **7.8 - Communication time**

### **7.9 - Cabin phone sound level adjustment**

### **7.10 - Periodic call validation (or cyclic test)**

### **7.11 - Cyclic test / Frequency**

7.11.1 - Call management Cyclic test

### **7.12 - Intercom mode gain settings for machinery and firefighters**

### **7.13 - Listening to data exchange**

### **7.14 - Programming access code modification**

### **7.15 - Cabin light control timer**

7.15.1 - Cabin light input management

### **7.16 - Management of extensions on DISCRI input**

### **7.17 - BOX-ENVOIS extension management**

## **8 - OPERATIONS**

### **8.1 - Cabin alarm test**

### **8.2 - Cabin roof technician alarm**

### **8.3 - Automatic hang-up (voice mode)**

### **8.5 - Green button functions**

## **9 - BOX TX+ FUNCTIONS**

### **9.1 - Voice synthesis on blocked user alarm**

### **9.2 - Alarm siren**

9.2.1 - Alarm siren on alarm button

<b>9.3 - BOX TX+ clock setting</b>	<b><u>Page 37</u></b>
9.3.2 - Local time display	
<b>9.4 - Floor statement</b>	
9.4.1 - Statement validation	
9.4.2 - Devalidation of statements	
9.4.3 - Level programming via keypad	
9.4.4 - Broadcasting between 8 a.m. and 8 p.m.	
9.4.5 - Indication of floor announcement period	
<b>10 - <u>SERVICE VOICE / ALARM ACKNOWLEDGEMENT</u></b>	<b><u>Page 40</u></b>
10.1 - Validation of «Alarm in Progress» & «Technician Arrival» announcements	
10.2 - Disabling of «Alarm in progress» & «Technician arrival» announcements	
10.3 - Cabin alarm acknowledgement	
<b>11 - <u>SPEAKER AND MICROPHONE TEST</u></b>	<b><u>Page 41</u></b>
11.1 - Periodic «call test»	
11.2 - Test on request operator	
<b>12 - <u>PRESENTATION OF THE TX+ VERSION</u></b>	<b><u>Page 42</u></b>
12.1 - Elevator monitoring	
12.1.1 - Validation of elevator monitoring mode	
12.1.2 - Learning procedure	
12.1.3 - Sheath learning launch	
12.2 - Event validation (Faults/Malfunctions)	
12.2.1 - Event validation sequence	
12.2.2 - Fault inhibition sequence	
12.2.3 - Event references	
12.2.4 – Reading fault validation	
12.2.5 – Door type reading	
12.2.6 – Programming inactivity time	
12.2.7 – Technical fault filtering	
12.3 - Commissioning checks	
12.3.1 - Door information control	
12.3.2 - Monitoring control	
12.3.2.1 - Check surveillance mode validation	
12.3.2.2 - Check synthesizer operation	
12.3.2.3 - Checking failure transfer	
<b>13 - <u>KEYBOARD PROGRAMMING TABLE</u></b>	<b><u>Page 50</u></b>
<b>14 - <u>KEYBOARD PROGRAMMING TABLE WITH BOX-INTENS</u></b>	<b><u>Page 52</u></b>
<b><u>NOTES AND WARRANTY</u></b>	<b><u>Page 53</u></b>

## 2 - GENERAL

### 2.1 - Technical data

- Complies with European standards **EN81-28** (2003 and 2022) and **EN81-70\***.
- Integrated or remote voice modules
- Triphonic function by adding **BOX-SC** or **BOX-C** modules
- Cabin roof mounting
- Remote-powered via analog telephone line or powered if the magnetic loop or green/yellow LEDs are connected
- Multifrequency dialing mode
- Automatic off-hook
- Volume and acoustics control (locally or remotely)
- Location recognition
- Send call location identification to **ANEPCenter®** or [anepanywhere.com](http://anepanywhere.com) website
- 12-key programming keypad
- 1 input from cabin alarm button (NO or NC)
- 1 button with two functions: blocked person alarm acknowledgement, technician arrival and departure.
- 1 cab roof technician alarm button
- 6 telephone number memories
- Automatic redial of second number in case of busy or no answer
- Battery and maintenance free EEPROM memories
- Cyclic test (1, 2 or 3 days)
- Remote programming possible with **ANEPCenter®**
- Synthesis circuit for floor announcements and voice messages
- 1 «Cabin light» input
- Elevator operation control (remote monitoring)

#### Factory settings

- |                        |             |
|------------------------|-------------|
| • Programming code :   | <b>*123</b> |
| • Communication time : | 3 minutes   |
| • Hung up :            | Automatic   |
| • Cyclic test :        | 3 days      |

\* Standard EN81-28 Remote alarm for new elevators since October 2003 and 2022  
Standard EN 81-70 Safety rules for the construction and installation of elevators Part 70: Accessibility to elevators for all persons including persons with disabilities.

### 3 - BOX TX+ CONNECTION (configuration example)

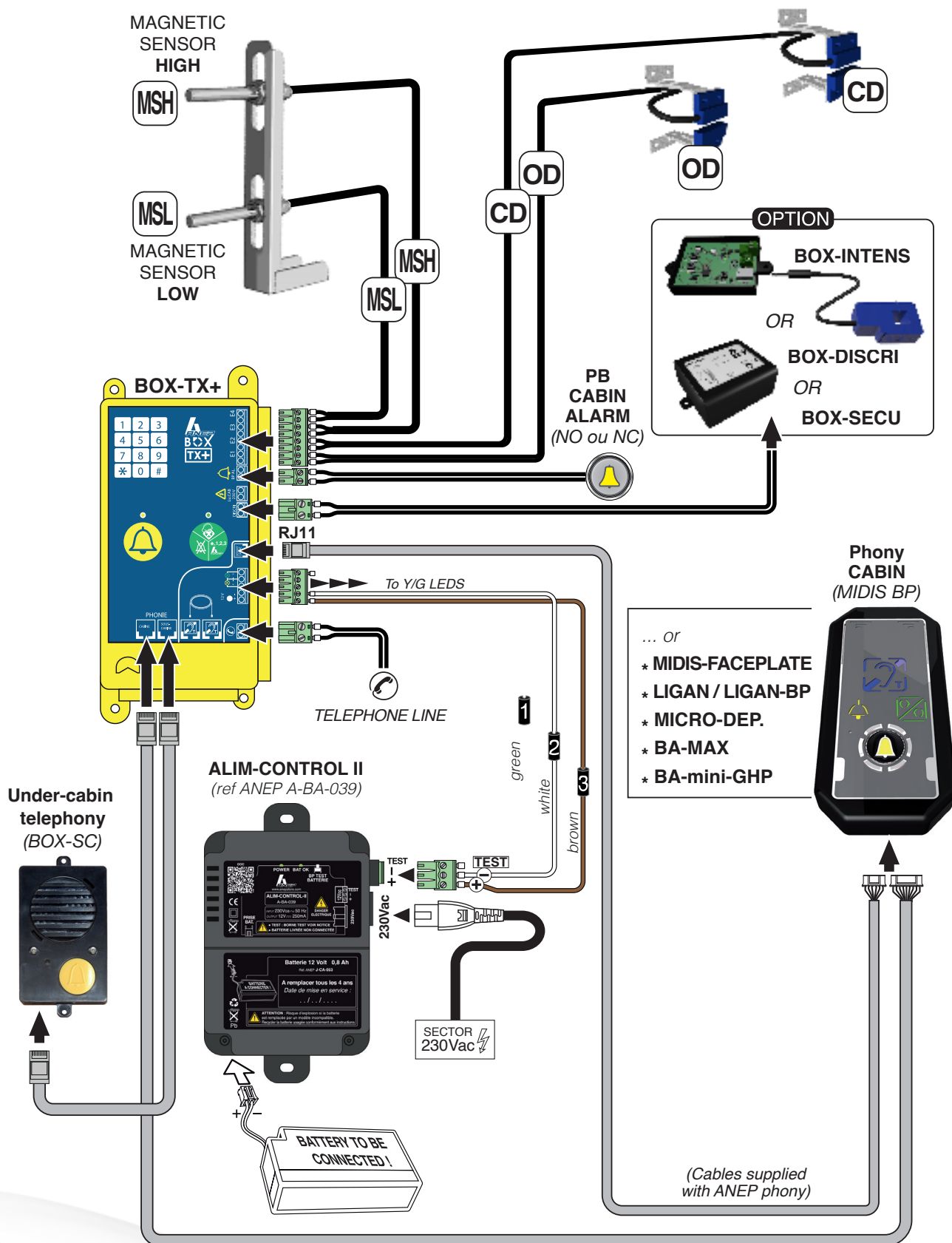

### 3.1 - SENSOR CONNECTION

Car door open/close and elevator travel information are connected to ANEP BOX inputs **E1** to **E4**.

**These inputs are provided with dry, potential-free contacts..**

- E1 - Cabin door OPEN**
- E2 - Cabin door CLOSED**
- E3 - Magnetic sensor HIGH**
- E4 - Magnetic sensor LOW**

**Note:** These 4 items of information are compulsory for the statements to work..

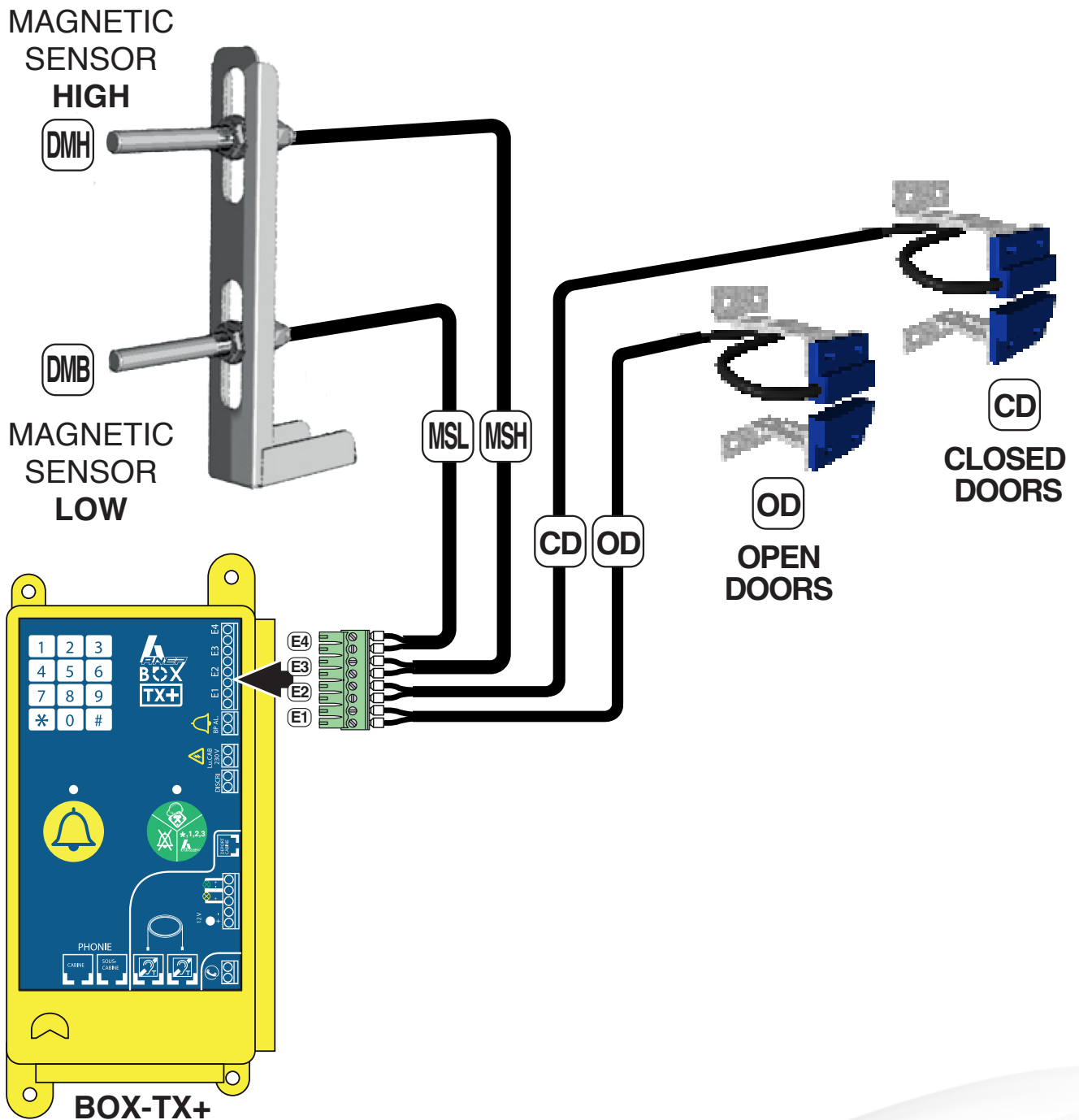



### 3.2 - CONNECTION OF POSITION / OFFSET SENSORS [E3] AND [E4].

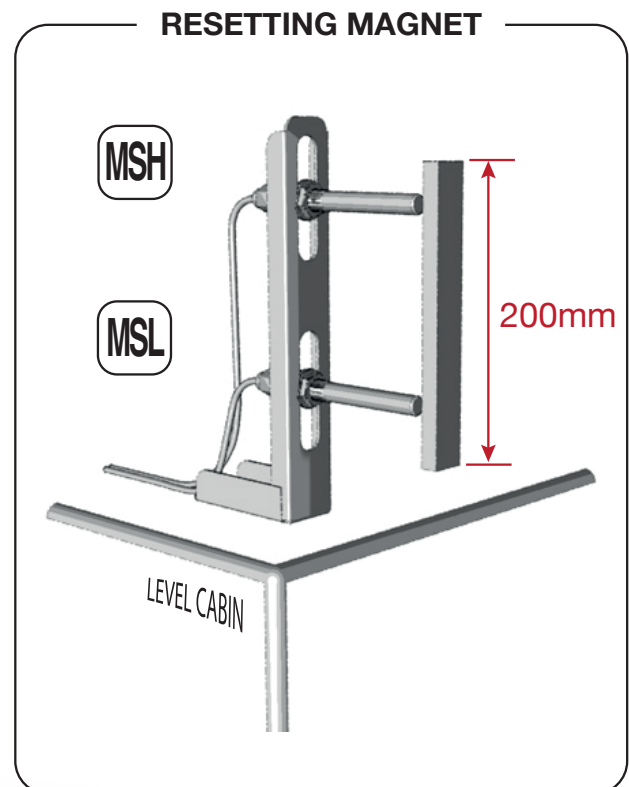
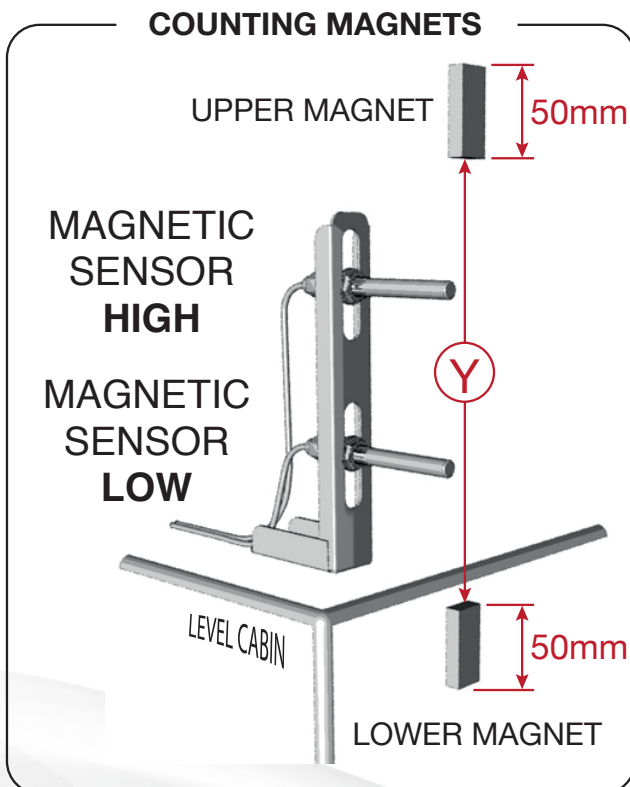
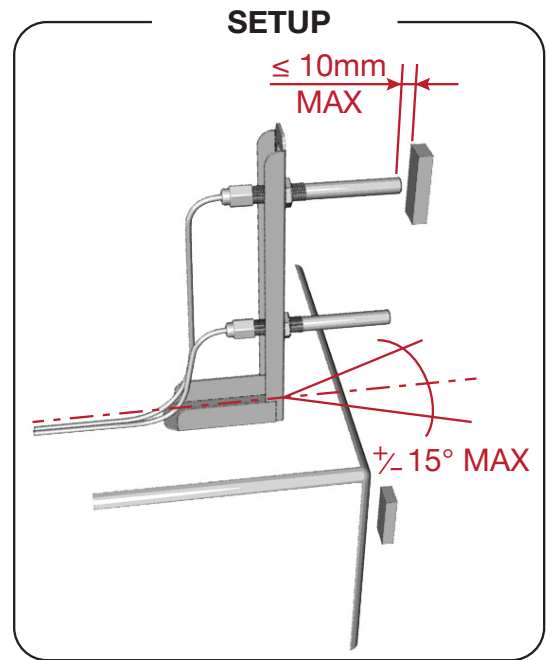
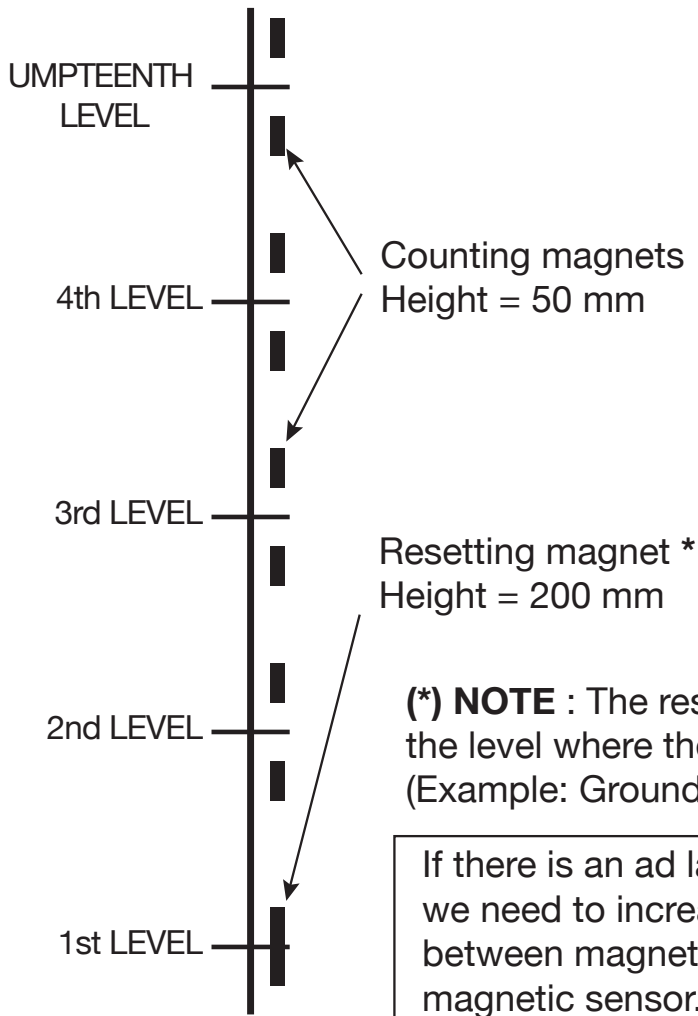

### 3.2.1 - Elevator with short floors

The minimum value for detecting short floors is **700mm** between two floors (floor information).

#### ELEVATION ELEVATOR SHAFT (example)

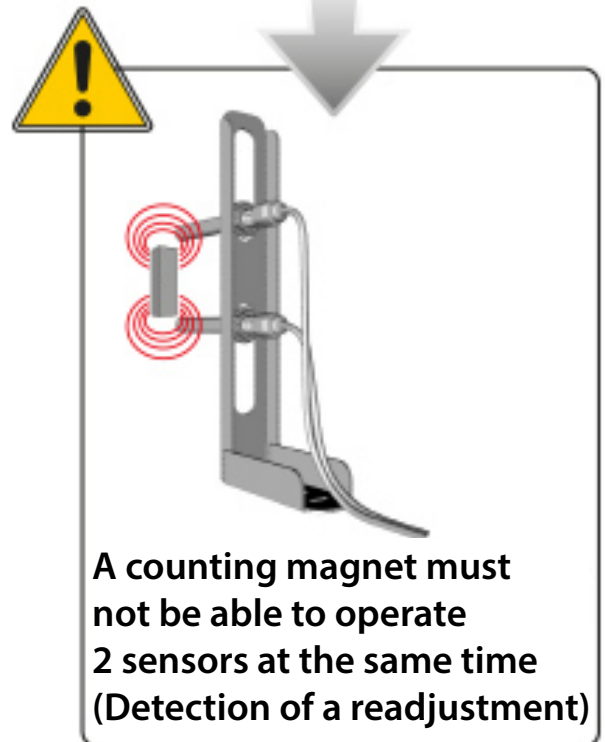
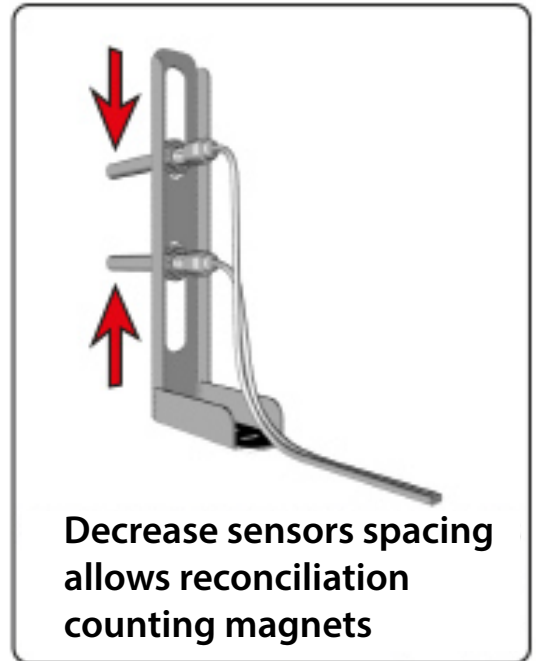
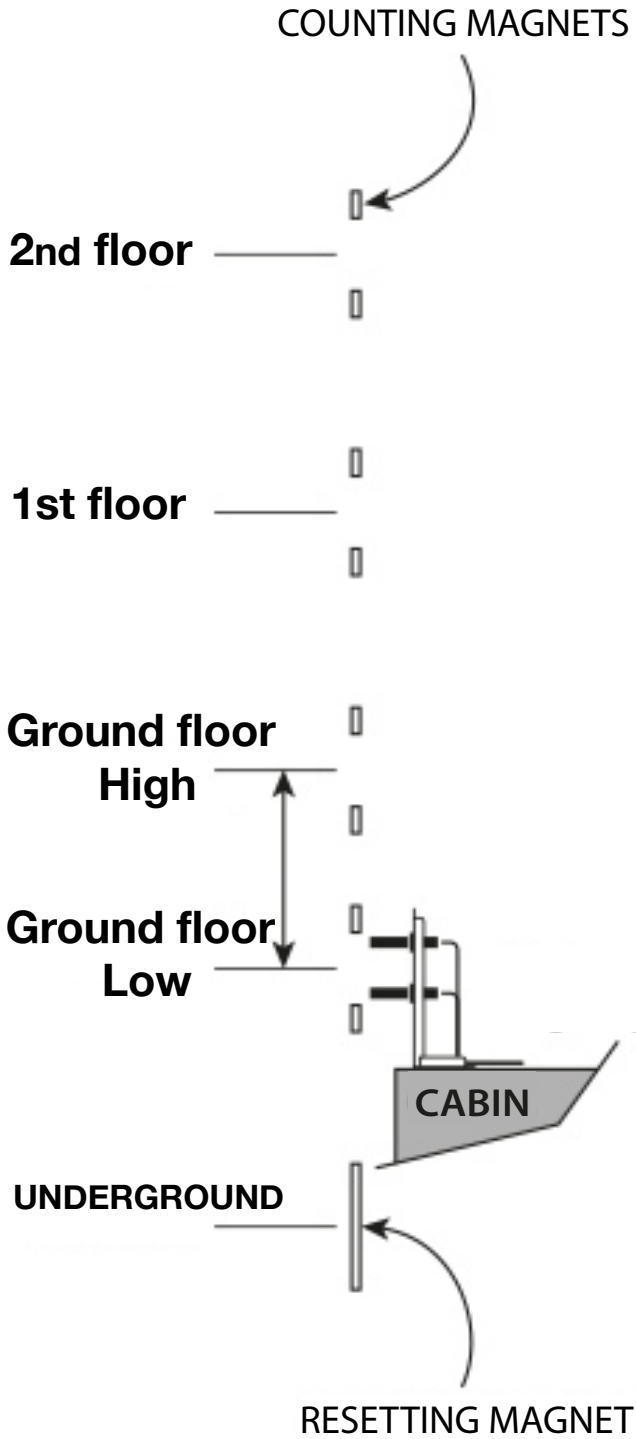

### 3.3 - PO\* and PF\*\* sensor connection [E3] and [E4].

\* DO = Door Open

\*\* DC = Door Closed

#### 3.3.1 - Single-access elevator.

Door information DO/DC is connected to inputs E1 (DO) and E2 (DC).

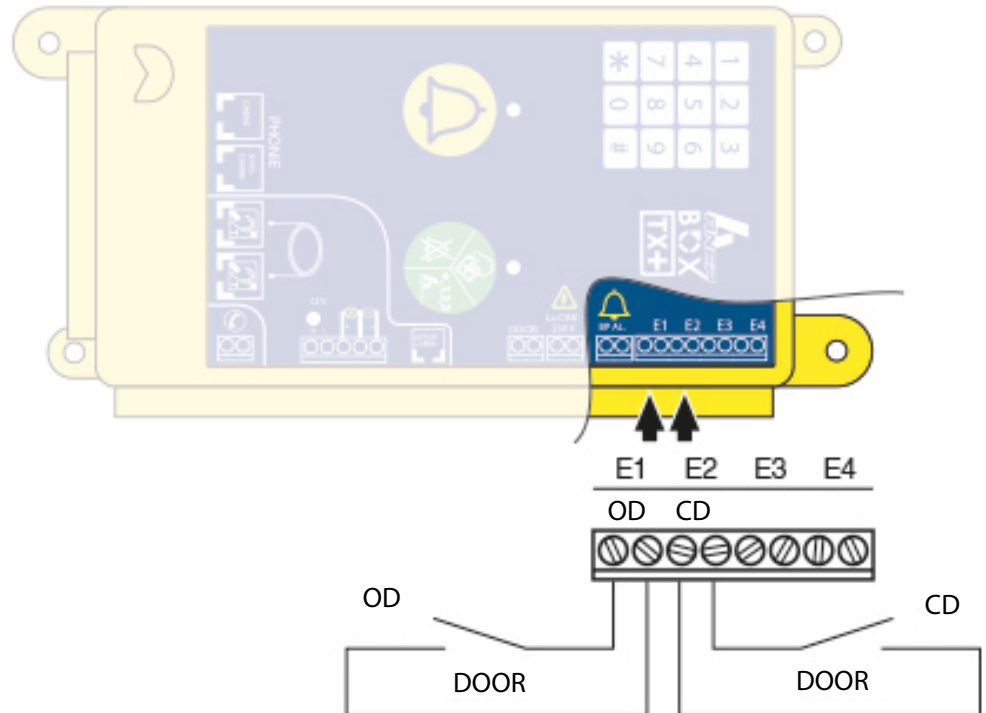

#### 3.3.2 - Dual-access elevator.

DO/DC door information must be doubled. (DO in parallel and DC in series)

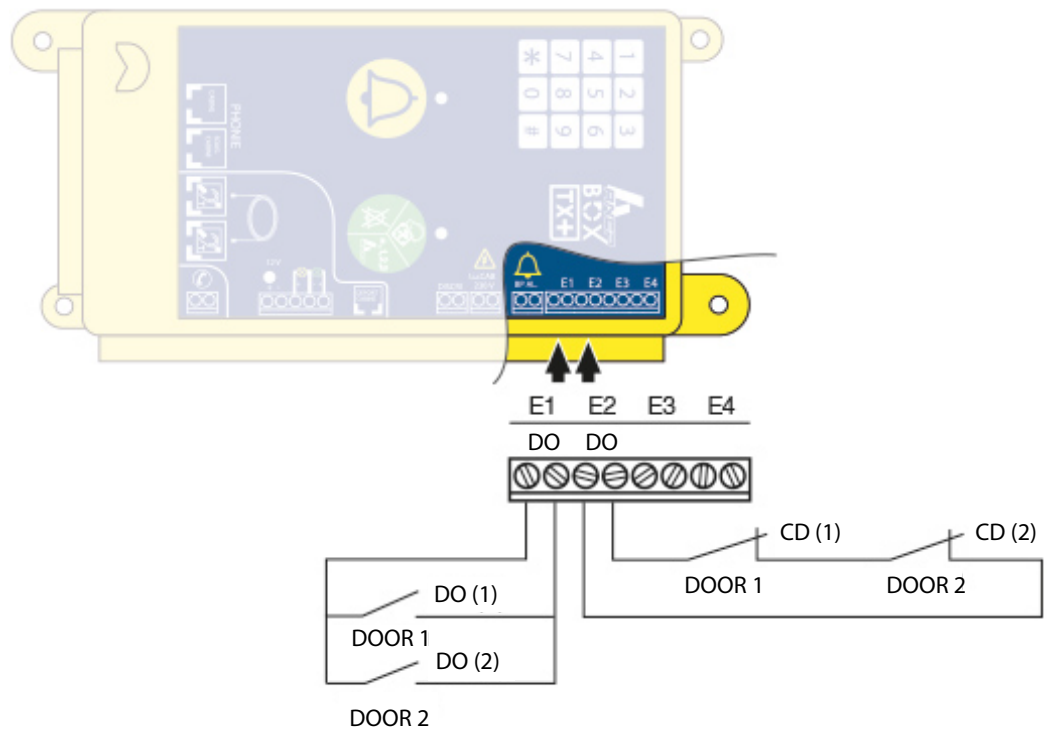

**NOTE: PF IS THE GONG STARTER**

**IF THE SYNTHESIS STARTS WHEN THE ELEVATOR STOPS BEFORE THE DOOR IS OPENED, A PF SENSOR IS INCORRECTLY SET.**

## 3.4 Programming for special cases

### 3.4.1 - Elevator with fully manual doors

The «Inactivity» time delay value must be greater than that for an elevator with automatic doors. (Manual door closing). All door faults must be deprogrammed, as door opening and closing depends on the user.

### 3.4.2 - Elevator with mixed doors (swing and automatic)

Programming: swing doors (even if only one swing door).

De-programming: start-up fault (elevator is parked in automatic doors).

If the lower end is an automatic door, start learning (alarm button) with the door open, then let it close after registering the upper command.

### 3.4.3 - Factory settings

The **BOX TX+** module is delivered with a set of parameters called «Factory Settings».

PARAMETERS	FACTORY CONFIGURATION
Programming code	* 123
Communication time	3 minutes
Hung up	Automatic
Periodic call frequency	3 days
Transmitter number	Factory serial number (8 digits, see label on box)
Module number	1
Telephone numbers	Not programmed (empty memories)
Telephone network	Analog telephone line (PSTN / RTC)
Cabin alarm Bt delay	1 second
Bt cabin alarm delay with BOX-DISCRI	25,3 seconds
Operator acquittal	Not validated
Yellow/Green indicator management	Standard 2003
Cabin light entry times	0 minutes
Discrimination Cabin alarm	Not validated
Loudspeaker activated during data transmission	Not validated
Speech synthesis for floor statements	Activated
Voice synthesis for service messages *	Activated
Remote monitoring functions	Not validated

#### (\*) **Service messages :**

Technician Arrival and Departure

Alarm in progress

#### 4 - YELLOW & GREEN LED CONNECTION (if MIDIS absent)

- Connect indicator lights used in the cab in accordance with standards NF EN 81.28 of 2003 or 2022 and 81.70 (12Vdc / 140 mA max per light) (see Page 14).
- Connect a 12Vdc power supply (from 9 to 15Vdc) type **ALIM CONTROL-II**.

**No such connection is required when using MIDIS phonics.**

*Common cathode indicators*

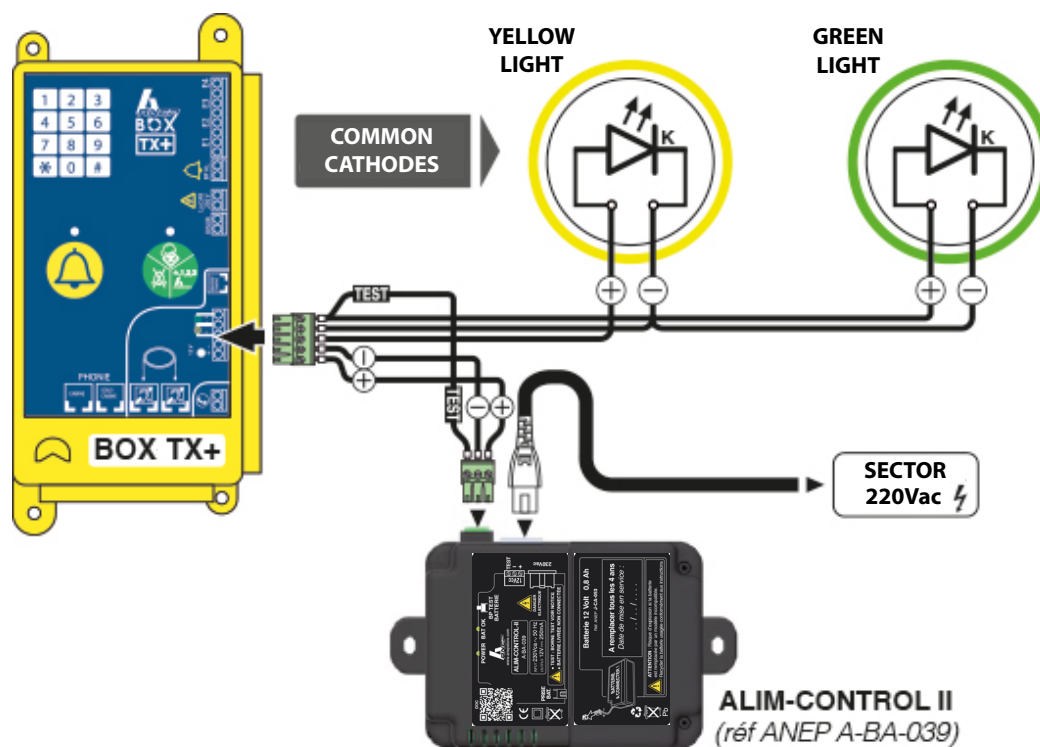

*Common LEDs*

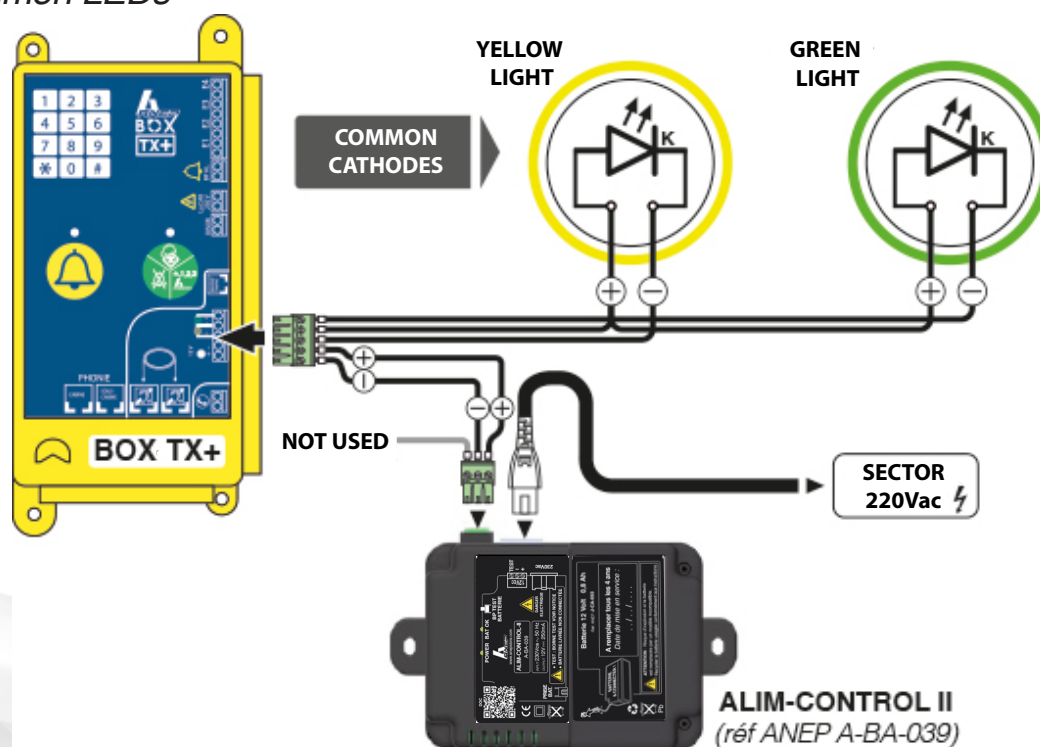

## 4.1 - Yellow & Green LEDs can be programmed according to EN81-28 2003 or 2022 standards

- ☞ In programming mode **\*123**
- ☞ Depending on the type of standard required for indicator management, successively press the **#417#, or #418#, or #419#**



<b>EN81-28 2003 STANDARD</b>	OFF ●	OFF ●	Standby / NORMAL MODE	<b>#417#</b>
	ON ✱	OFF ●	Alarm activated, call in progress	
	OFF ●	ON ✱	In communication with a call center operator	
	OFF ●	OFF ●	Communication ended, line hung up, Alarm acknowledged (remote or on-site)	

<b>EN81-28 2022 STANDARD</b>	OFF ●	OFF ●	Standby / NORMAL MODE	<b>#418#</b>
	ON ✱	OFF ●	Alarm activated, call in progress	
	ON ✱	ON ✱	In communication with a call center operator	
	ON ✱	OFF ●	Call ended, line hung up	
	OFF ●	OFF ●	<b>Acknowledged alarm</b> (remote or on-site)	
	FLASHES ✱(✱) ✱(✱)	FLASHES (✱) ✱(✱)	Programmed cyclic test fault	

<b>EN81-28 2022 STANDARD  YELLOW OFF</b>	OFF ●	OFF ●	Standby / NORMAL MODE	<b>#419#</b>
	ON ✱	OFF ●	Alarm activated, call in progress	
	ON ✱	ON ✱	In communication with a call center operator	
	OFF ●	OFF ●	Call ended, line hung up	
	OFF ●	OFF ●	<b>Acknowledged alarm</b> (remote or on-site)	
	FLASHES ✱(✱) ✱(✱)	FLASHES (✱) ✱(✱)	Programmed cyclic test fault	

Programming on ANEP BOX keypad

After activating the programming access mode *123	
<b>#417#</b>	Validates management of Yellow and Green LEDs to <b>2003</b> standards
<b>#418#</b>	Validates the management of Yellow and Green lights to <b>2022</b> standards
<b>#419#</b>	Validates management of yellow and green LEDs to <b>2022</b> standards, with yellow <b>LED off</b> after communication (end of alarm).

## 5 - CABIN ALARM DISCRIMINATION

- Alarm discrimination is used to prevent untimely, unfounded alarms being transmitted as a result of incorrect use or malicious intent.
- Discrimination can be carried out either internally or externally, or not validated. When a technician is present, discrimination is not carried out.

### 5.1 - Discrimination not validated

This configuration mode enables the cabin alarm to be taken into account permanently.

- ☞ In programming mode **\*123** (see Page 18)  
Successively press the **#307#**  
**ANEP BOX TX+** beeps 3 times 

### 5.2 - Internal discrimination

In this mode, **ANEP BOX TX+** processes the opening and closing of car and landing doors, as well as the movement of the elevator.

Inputs **E1**, **E2** receive the **DO**, **DC** contacts of the cabin door.

The alarm is discriminated :

- When the elevator moves.
- For the first 15 seconds after the elevator has stopped at the floor.
- When both cabin and landing doors are open.

- ☞ In programming mode **\*123** (see Page 18)  
Successively press the **#308#**  
**ANEP BOX TX+** beeps 3 times 

### 5.3 - External discrimination BOX-DISCRI / DISCRI input extension

See page 31

### 5.4 - Forced alarm

When discrimination is enabled, the cabin alarm can still be triggered if the cabin button is pressed 4 times within 15 minutes. Each time the button is pressed, it must be held for longer than the programmed acknowledgement time, and the button must be released for at least 3 seconds between each press.

## 6 - ADDRESSING AND PROGRAMMING THE TRANSMITTER NUMBER

### Programming the transmitter number (or Identifier or PROM) :

The **ANEP BOX** module identifies itself in data mode by sending its «Transmitter number» (also called Identifier or PROM depending on the call center).

This number corresponds to the serial number of the **ANEP BOX** module.

This transmitter number can be modified to adapt to the different databases of the receiving centers.

**Note:** The transmitter number is numeric and has 8 digits.

Ex : 5 2 2 1 1 5 6 9



**ATTENTION: changing the transmitter number does not require prior access to programming.**

**\*#22220 xx xx xx xx #\***

xx xx xx xx = 8-digit transmitter number

### 6.1 - Addressing Module number :

Multiple **ANEP BOX** modules can be installed on the same telephone line (up to a **maximum of 8**), but each module's address must be configured.

In programming mode :

- #303** then **1 #** if module **1** (Elevator 1)
- or **#303** then **2 #** if module **2** (Elevator 2)
- or **#303** then **8 #** if module **8** (Elevator 8)

**Note :** Module = ANEP **BOX TX** (or **TX+**)  
or ANEP **BOX-C** (pit bottom)



BOX-C



Configuration 1 - Remote pit telephony with BOX-C

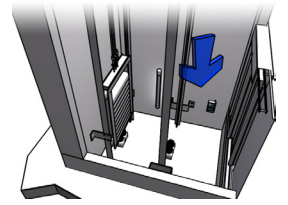

Addressing on **4 BOX TX+** and **4 BOX-C**

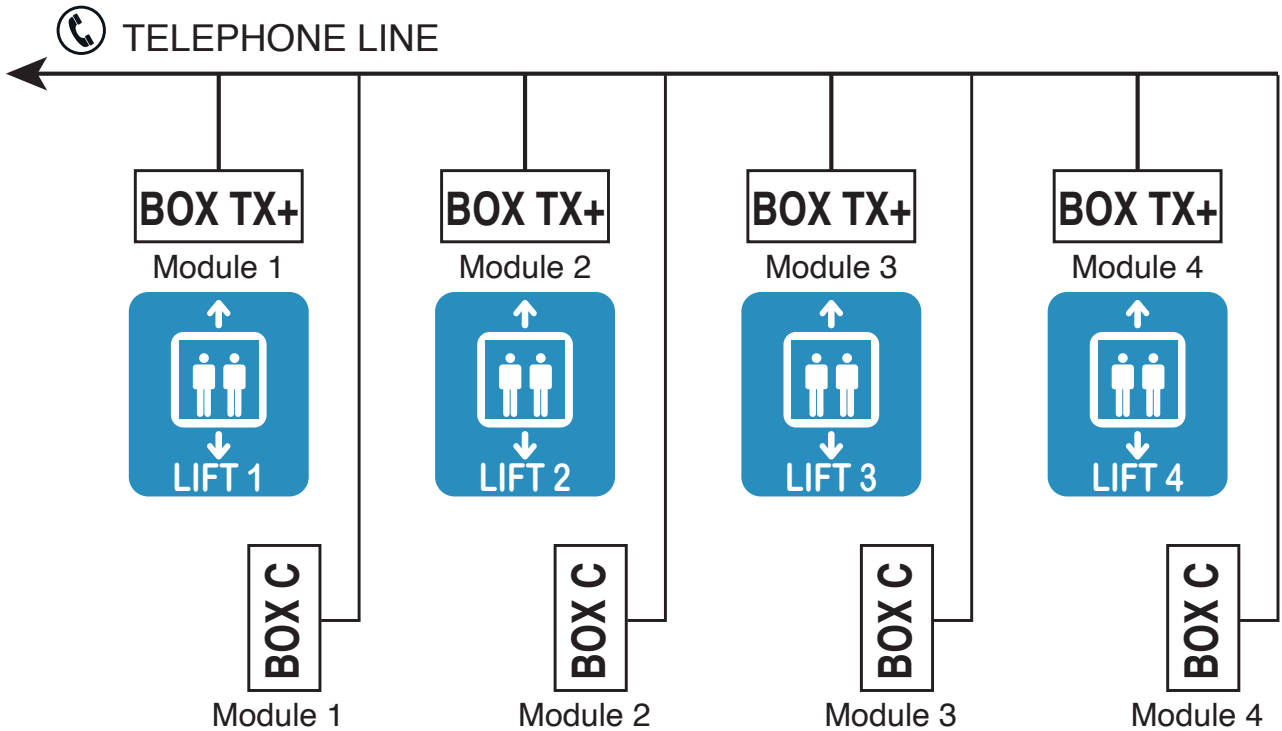

Configuration 2 - Embedded hardware with BOX-SC (8 maximum)

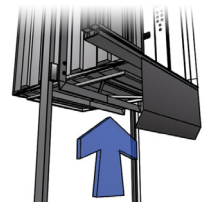

Addressing to be carried out on the **8 BOX TX+** units

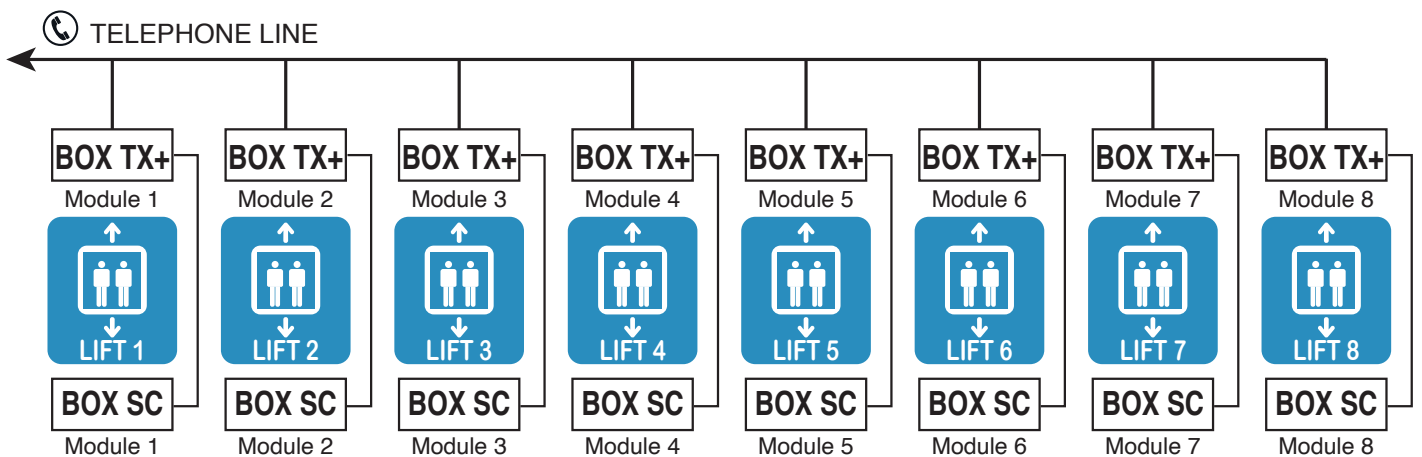

**NOTE:** These quantities are to be divided by 2 when using a **GSM gateway**.

=> **4x BOX TX+** with **BOX-SC** (under cab)

=> **2x BOX TX+** with **BOX-C** (pit bottom)

## 7 - PROGRAMMING (ANEP BOX hung up)

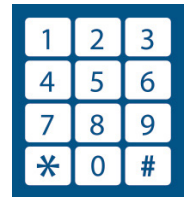

### IMPORTANT :

- All **ANEP BOX TX+** devices connected to the same telephone line must be connected to enable access to programming mode.
- Programming is performed using the **ANEP BOX TX+** keypad.
- To prevent unwanted manipulation, access to **ANEP BOX TX+** programming is protected by a three-digit access code:

**\*123**

- This code can be modified by the user (1 to 7 digits) (See page 27)

### 7.1 - Access to programming

Type \* followed by the digits of the programming access code

Example: (With factory default code)

→ \* **123** The device emits a melody 

The device is now in programming mode.

... 2 « beeps » every 20 seconds 

### 7.2 - Exit programming mode

When you have finished programming the device

→ Press the « \* »

End of programming, the device emits a melody 

**Note:** If no key is pressed for 3 minutes, the device exits programming mode.

The device emits a melody 

## 7.3 - Choice of telephone network

The **BOX TX+** module uses a telephone network to transfer alarms to a reception center. To ensure correct operation of the equipment, it is important to indicate the type of network between :

- Switched telephone network (analog PSTN),
- GSM Gateway,
- Autocom mode.

The choice of network affects the following functions :

- GSM Gateway battery charge information (**PG1**, **PGU**, **P3GU** and **P4GU** models only)
- Loudspeaker and microphone phonics control,
- Secure data transfer to a reception center

Autocom mode allows **BOX TX+** to operate with most autocoms, but does not guarantee operation with ALL autocoms on the market.

This mode allows:



- Numbering with quiescent line voltages between 20 and 28v,
- Off-hook if ringing time exceeds 400ms

### 7.3.1 - Standard mode

If the voltage of your Orange or other telephone line is higher than **28V**, you must configure your equipment in «Standard mode» (Orange line) and Normal line voltage (Line voltage > **28V**).



This is the mode in which your equipment was delivered (factory mode).

To ensure this, perform the following programming sequence.

- In programming mode **\*123**  
Press the **#404#**  
The device emits a melody   
Exit programming mode by pressing the « **\*** »,  
The device emits a melody 

### 7.3.2 - Autocom mode and/or low line voltage



If your equipment is connected to an Orange (or other operator) line, but the line voltage at rest is low (less than 28V), you must configure your equipment in «Autocom Mode and/or Low Line Voltage» (**20V** <= Line Voltage < **28V** ).  
Pour cela, effectuer la séquence de programmation suivante

- In programming mode **\*123**  
Press the **#403#**  
The device emits a melody   
Exit programming mode by pressing the **\***  
The device emits a melody 



### 7.3.3 - GSM Mode

If your equipment is connected to a GSM gateway, you must configure your equipment in «**GSM mode**».

Validation du mode «**GSM**»

- In programming mode **\*123**  
Press the **#405#**  
The device emits a melody   
Exit programming mode by pressing the **\***  
The device emits a melody 

Disable «**GSM**» mode / return to Standard mode,



- In programming mode **\*123**  
Press the **#406#**  
The device emits a melody   
Exit programming mode by pressing the **\***  
The device emits a melody 

## 7.4 - Number programming

1	2	3
4	5	6
7	8	9
*	0	#

### 7.4.1 - Programming a memory

Example: Programming Memory 101 (Main phone call)





- In programming mode **\*123**  
Press the **#101**  
The device emits a melody 
- Dial the number followed by **#**.  
The device emits a melody 

### 7.4.2 - Programming a memory with a pause (autocom)

In the case of installation behind a private branch exchange, it is necessary to dial a prefix followed by a pause and the call number.



To program a PAUSE (2 seconds), press the **\***

Example: (Pause after prefix 0) for memory 102

-  In programming mode **\*123**
-  **#102 0 \* 0145692800**
-  Press the « **#** » to validate  
The device emits a melody 

### 7.4.3 - Delete a number

-  Press the «**#**» key, then the memory number and the «**#**» key.  
Example: (Delete number in memory **102**)

-  In programming mode **\*123**
-  **#102#**  
The device emits a melody 

**Note:** If no action is taken on the keypad for **20 seconds**, the unit emits a «**BEEP**», and returns to the beginning of the phone number memory selection.

## 7.5 - Memory allocation



Alarm button  
Memory 101  
Memory 102

### 7.5.1 - Transfer method

ANEP devices can be programmed according to the desired use and the technology used at the alarm reception center, and the identification of the location and establishment of voice communication can be carried out in a single communication, or in two separate communications.

The recommended method, in line with the standard, corresponds to the single communication method (optimized delay for identification and voice dialogue).



If your reception center uses the two-way communication method, please contact us.

### 7.5.2 - Single communication programming table.

MEM.	Type of information	
	<b>*123</b>	Programming access code
<b>#001#</b>	RESET	Reset settings Memory deletion
<b>#101</b>	Phone number + #	Main voice
<b>#102</b>	Phone number + #	Phonie secondaire
<b>#104</b>	Phone number + #	Remote monitoring data Technician arrival/departure Battery status
<b>#105</b>	Phone number + #	Cyclic call
<b>#106</b>	Phone number + #	Call to ANEPanywhere®
<b>#303</b>	Module number	Module numbers 1 to 8
<b>#706</b>		End of automatic alarm activated
	* Exit programming mode	

### 7.5.3 - Configuring «dual call» mode

**Dual call** mode allows you to call a guard station (voice only), before transmitting the alarm to the reception center (data and voice). Telephone memories **101** and **102** are used for this function. To enable double call mode: In programming mode **\*123**

☞ Press the **#206#** The device emits a melody 

To deactivate the double call mode enter the sequence **#207#**

«Telephone» memories must be set as follows:

Memory **101**: Caretaker or PC-SECU or Call-center telephone number.

Memory **102**: Reception center phone number.

Alarm sequence :

When an alarm is triggered, the transmitter calls the number in memory **101** (guard). It then calls the number in memory **102** (reception center).

If the number in memory **101** (guard) or **102** (reception center) is busy, these numbers are called up to **six times** (6x memory 101 and 6x memory 102).

## 7.6 - Parameter validations and settings (in programming mode)

### 7.6.1 - Delay time after cabin alarm button is pressed

(between 0.5 and 6 seconds MAXI, default value 0.5 seconds)

- ☞ In programming mode **\*123**  
Press the **#302** and the time defined in 10ths of a second  
The unit emits 3 «beeps»   
Press **#** to confirm

Example: Delay of 4.5 seconds  
☞ Press the **#302 45#**

## 7.7 - Blocked person call acknowledgement (EN81-28) by #1

When this function is enabled, an alarm call from ANEP BOX must be acknowledged by the operator by dialing «#1» on the telephone keypad (in DTMF mode) during voice communication.

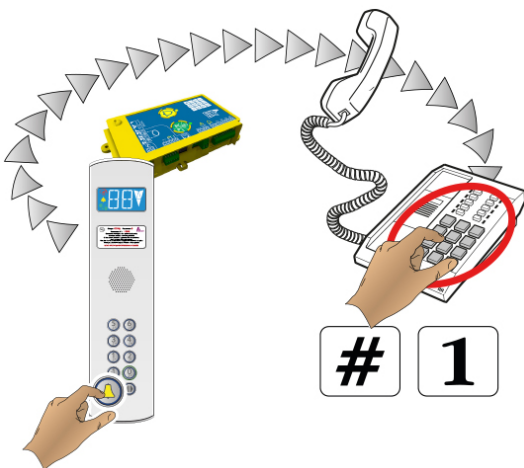

If this operation is not performed, **ANEP BOX** calls the reception center 6 times per programmed call number (see 7.4.1).

To enable this function, To disable call acknowledgement.

- In programming mode **\*123**  
Press the **#202#**
- In programming mode **\*123**  
Press the **#203#**

The unit emits 3 «beeps»' 

The unit emits 3 «beeps» 

## 7.8 - Communication time

Talk time from **1** to **99** minutes (factory setting = 3 minutes)

- In programming mode **\*123**  
Press the : **#201** puis ..  
... enter the desired maximum talk time
- Press the **#**  
The device emits a melody 

## 7.9 - Cabin phone sound level adjustment

After programming, trigger a call by pressing the alarm button **in the cabin** for ANEP BOX or the button. 

The following settings are available to adapt ANEP BOX sound levels and microphone/speaker to local conditions.

→ Key **6** = **+**      Key **9** = **-**

This setting changes the speaker volume after the toggle.

→ Key **5** = **+**      Key **8** = **-**

This setting changes the microphone sensitivity

Press 0 to hang up the device.

Key 1 returns to factory settings.



Changes made in manual setting mode replace those previously made in automatic setting mode.

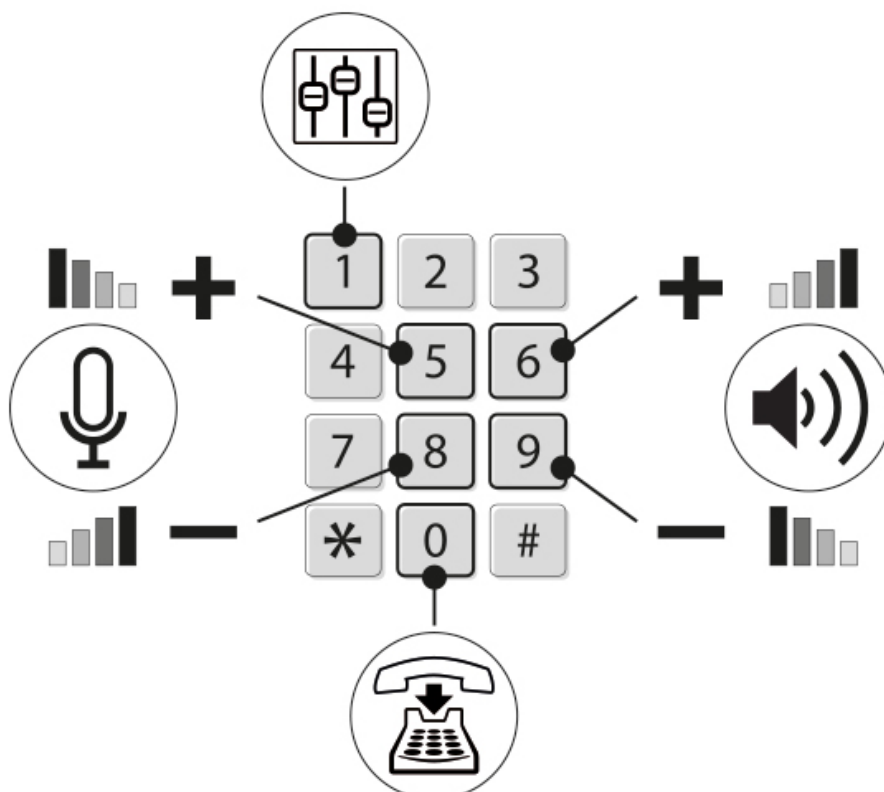





## 7.10 - Periodic call validation (or cyclic test)





A «site card» must first be created using ANEPcenter® software (see ANEPcenter® manual) or a call center equipped with ANEP protocol.

- In programming mode **\*123**  
Successively press the **#105**  
The unit emits 3 «beeps» 
- Dial the number to receive data to the reception center equipped with FT1000 Modem and ANEPcenter® software or compatible front-ends.
- Press the **#**  
The device emits a melody 

**NOTE:** The periodic call resets the **ANEP BOX TX+** clock.

## 7.11 - Cyclic test / Frequency

- In programming mode **\*123**  
Successively press the **#301**  
The unit emits 3 «beeps» 
- Enter the number of days for cyclic call frequency 1, 2 or 3.  
Default: 3 days                    exemple : 2 days = **#301 2**
- Press the **#**  
The device emits a melody 

## 7.11.1 - Call management Cyclic test

If memory **106** is programmed, all calls made from memories **101** to **105** are sent to systematic memory **106**.

It is possible not to send the cyclic call to ANEPAnywhere®.

To validate the cyclic call to ANEPAnywhere® (default)

- In programming mode **\*123**  
Successively press the **#901#**  
The device emits a melody   
Exit programming mode by pressing the **\*** key.

To disable the cyclic call to ANEPAnywhere®, follow these steps

- In programming mode **\*123**  
Successively press the **#902#**  
The device emits a melody   
Exit programming mode by pressing the **\*** key.

## 7.12 - Intercom mode gain settings for machinery and firefighters

Loudspeaker and microphone gains used for machinery intercom and firefighter module functions can be set independently. These settings do not modify the settings defined for traditional triphony functions.

### Microphone gain adjustment

- In programming mode **\*123**  
Press **#407** then a value from **1** à **15**, and **#**  
(1 = min gain, 15 = max gain)

### Speaker gain adjustment



- In programming mode **\*123**  
Press **#408** then a value from **1** à **15**, and **#**  
(1 = min gain, 15 = max gain)

## 7.13 - Listening to data exchange

To let the elevator technician know that the ANEP-BOX module is communicating with a central reception unit, all data exchanges are audible (low level) through the ANEP-BOX loudspeaker.

**IMPORTANT** : No action possible on **ANEP-BOX** during communication phase.

## 7.14 - Programming access code modification

- Successively press the **#002**  
The unit emits 3 «beeps» 
- Enter the new programming code (1 to 7 digits) and «#».  
The unit emits 3 «beeps» 
- Confirm the new programming code (1 to 7 digits) and «#».  
The device emits a melody 



It is important to make a note of the new programmed code.  
If you lose it, you'll have to return the unit to the factory.

## 7.15 - Cabin light control timer

**ANEP BOX TX+** controls the «Cabin light» voltage (230Vac). The fault and the return of this voltage are transmitted to a central receiver (Telephone memory 104).

The time delay for acknowledging the return of voltage is set to 2 min.  
The time delay for acknowledging the fault is programmable.

- In programming mode **\*123**  
Press **#304**, then set time in minutes (from 0 to 99)  
ANEP-BOX emits «3 beeps»   
Press **#** to confirm

When the time delay is 0, the «Cabin light» fault is not processed (factory setting).

### 7.15.1 - Entrance management -Cabin light-

#### 1 / Cabin light function (default mode)

The CABIN LIGHT input manages the «*Cabin Light Control*» function when the «Cabin Light Tempo» parameter is non-zero.

- In programming mode **\*123**  
Press **#306 0** then refer to chapter 7.15 to set the timer value  
ANEP-BOX emits «3 beeps»   
Press **#** to confirm



#### 2 / Elevator entrance with reservation

When a voltage (5V to 230V) is applied to the input, an «*Elevator in reservation*» message is transmitted. The activation delay is set to 6 sec.

- In programming mode **\*123**  
Press **#306 1** to validate the function  
ANEP-BOX emits «3 beeps»   
Press **#** to confirm

### 3 / Entry Arrival & Departure Maintenance technician

The Cabin Light input can be used to signal the start/end of a visit. Maintenance when «Cabin Light Time» is set to zero.

The presence of a voltage (5V to 230V) on the input for 5 seconds activates the «Maintenance visit» start.

- The voice message «Technician has arrived» is heard.
- Transmission of the «Technician presence for maintenance visit» event is delayed by 5 minutes.

→ In programming mode **\*123**  
Press **#306 2** to confirm the function  
ANEP-BOX emits «3 beeps»   
Press **#** to confirm

#### ▶ Start of visit Maintenance

The presence of a voltage (5V to 230V) on the input for 5 seconds activates the «Maintenance visit» start.

- The voice message «*Technician has arrived*» is heard.
- Transmission of the «*Technician presence for maintenance visit*» event is delayed by 5 minutes.

#### ▶ End of visit Maintenance

The disappearance of voltage on the input for 5 seconds indicates the end of the «*Maintenance Presence*»..

- The voice message «Départ Technicien» (Technician departure) is heard.
- The «Disappearance Technician Presence» event is transmitted immediately.

## 7.16 - Management of extensions on the DISCRI input

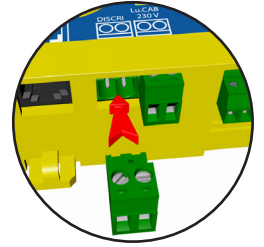

Depending on the type of function required, the «**DISCRI**» input can be used to connect an optional extension.

**OPEN DOOR**, using an external device (such as Prudhomme etc ...), it is possible to detect and make a call when a door is open to empty space.

**BOX-INTENS** (see also **BOX-INTENS** manual and page 49-50 of this manual) Detects elevator operation by detecting current consumption.

**BOX-DISCRI** (see also **BOX-DISCRI** manual) Discriminates unfounded alarms by detecting elevator movement.

**BOX-SÉCU** (see also manual **BOX-SÉCU**) (from version **TPL 00-A**) Allows detection of faults and malfunctions by sensing points in the elevator operation.

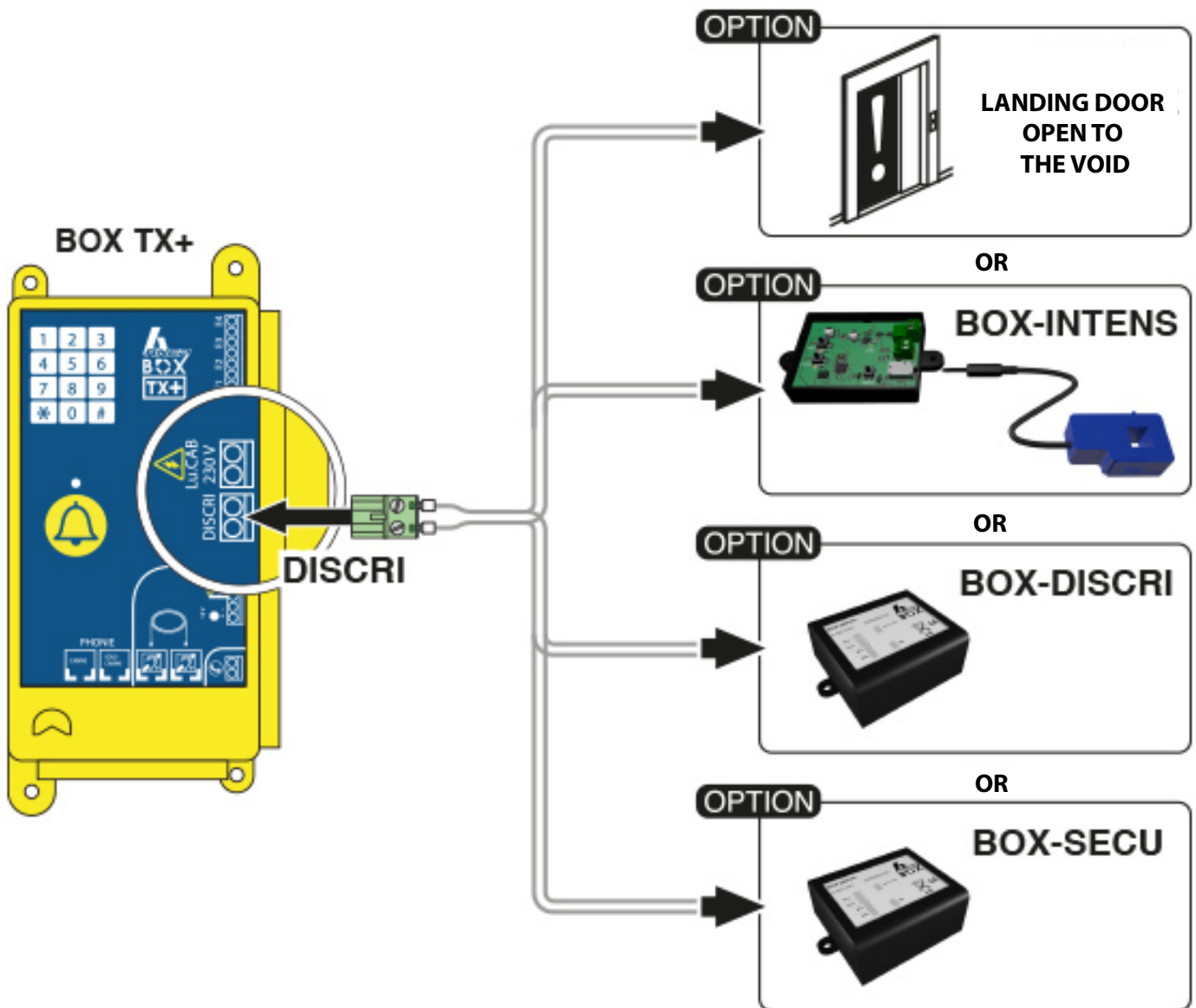

## OPEN DOOR

Via an external system (Prudhomme type, for example), the DISCRI input can be used to transmit «landing door open to empty space» information (if the car door is closed).

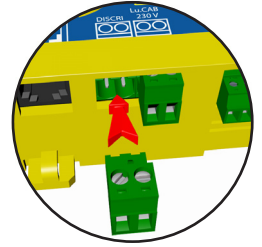

- In programming mode **\*123**  
Press **#305 xx #** to confirm the function  
*xx is the landing door opening delay value (step is 2.5 sec).*  
ANEP-BOX emits «3 beeps»   
Press **#** to confirm

If xx is set to 0, the input is used for external discrimination (default value, see CABIN ALARM DISCRIMINATION on page 15).

If a BOX SECU or BOX-INTENS is connected, this cancels all configurations made on this input.

**BOX-INTENS** (see also **BOX-INTENS** manual and page 49-50 of this manual)  
Detects elevator operation by detecting current consumption.

**BOX-DISCRI** (see also **BOX-DISCRI** manual) Discriminates unfounded alarms by detecting elevator movement.

**BOX-SÉCU** (see also manual **BOX-SÉCU**) (TPL 00-A version and higher) Allows detection of faults and malfunctions by sensing points in the elevator operation.

## 7.17 - BOX-ENVOIS extension management (optional)

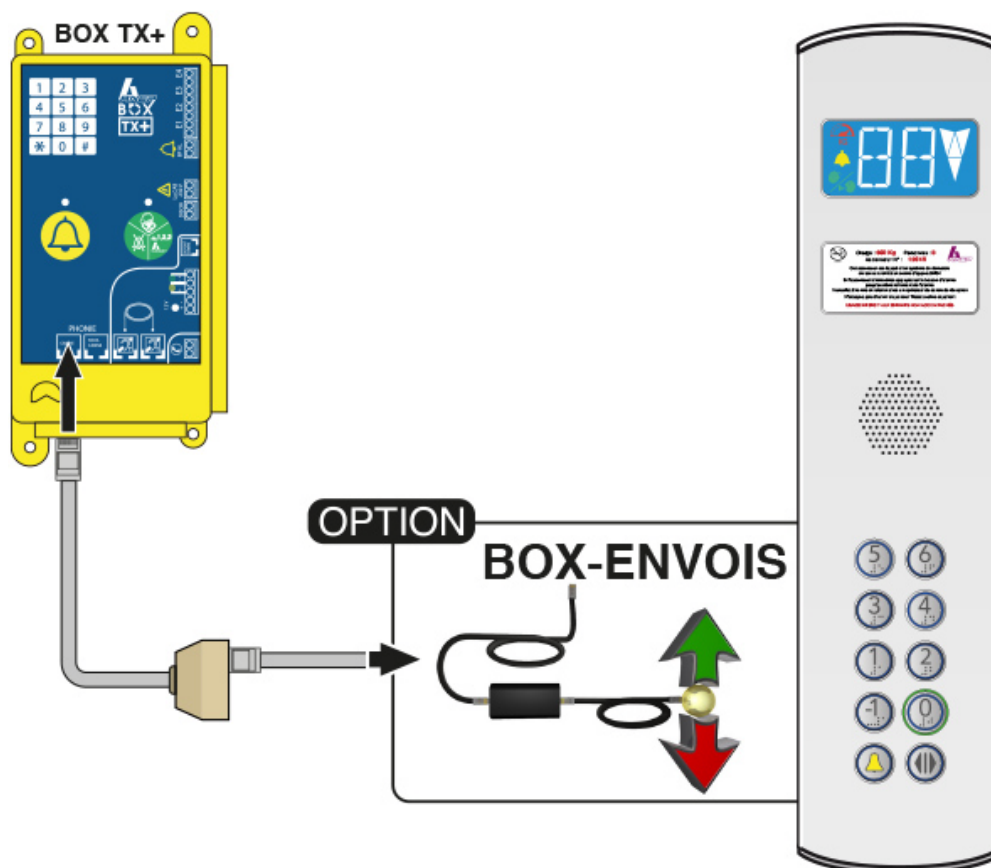

### BOX ENVOIS

The cab voice output can be used to move the cab by adding the BOX-ENVOIS extension (optional, see BOX-ENVOIS manual).

On the **BOX TX+** keypad :

To validate the Up/Down send function :

- In programming mode **\*123**  
Press **#704#** to validate the BOX-ENVOIS function  
ANEP-BOX emits «3 beeps» 

To disable the Up/Down send function (default) :

- In programming mode **\*123**  
Press **#705#** to disable the BOX-ENVOIS function  
ANEP-BOX emits «3 beeps» 



## 8 - OPERATIONS

### 8.1 - Cabin alarm test

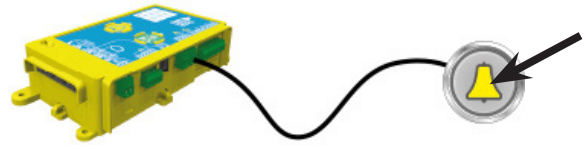

Following an alarm for a user trapped in the cabin, the alarm can be terminated automatically:

- Or after a 1-hour delay (\*)
- Or after 2 cabin strokes with 2 door openings (Remote monitoring mode activated and duct magnets and PO-PF detected).
- Via **BOX-SECU** or **BOX-INTENS** (new)

To enable this function :

- In programming mode **\*123**  
dial sequence **#706#**  
The device emits a melody   
Exit programming mode by pressing the **\***

To disable this function (default)

- In programming mode **\*123**  
dial sequence **#707#**  
The device emits a melody   
Exit programming mode by pressing the **\*** key



Press the cabin alarm button. If discrimination is not activated, the voice message «Your call has been recorded, please wait» is played and ANEP BOX calls the correspondent (see page 15).

«**Beeps**» are emitted every 6 seconds if there is silence, to indicate that the device is on line. 

To make it easier to trigger the «**user in cabin**» alarm, try :

- Door closed or operating
- Technician presence activated
- Forced alarm

At the end of the automatic alarm, the «**End of alarm**» message is announced by the voice synthesizer, and the «**Appearance End of automatic alarm**» information is transmitted via telephone memory 104.

The «**End of alarm**» function can always be performed locally using the green button, or remotely via ANEPCenter®.

(Following return to Factory settings (**#001#**), the automatic alarm termination function is not enabled)

## 8.2 - Cabin roof technician alarm

- Press the alarm button on the **ANEP BOX TX+** module.

The voice message «*Your call has been recorded, please wait*» is played, **ANEP BOX TX+** calls the reception center.

«*Beeps*» are emitted every 6 seconds if there is silence, to indicate that the device is on line. 



## 8.3 - Automatic hang-up (voice mode)

Hang-up occurs automatically when the telephone line is busy or when the call duration has expired (default: 3 minutes).

Busy signal :

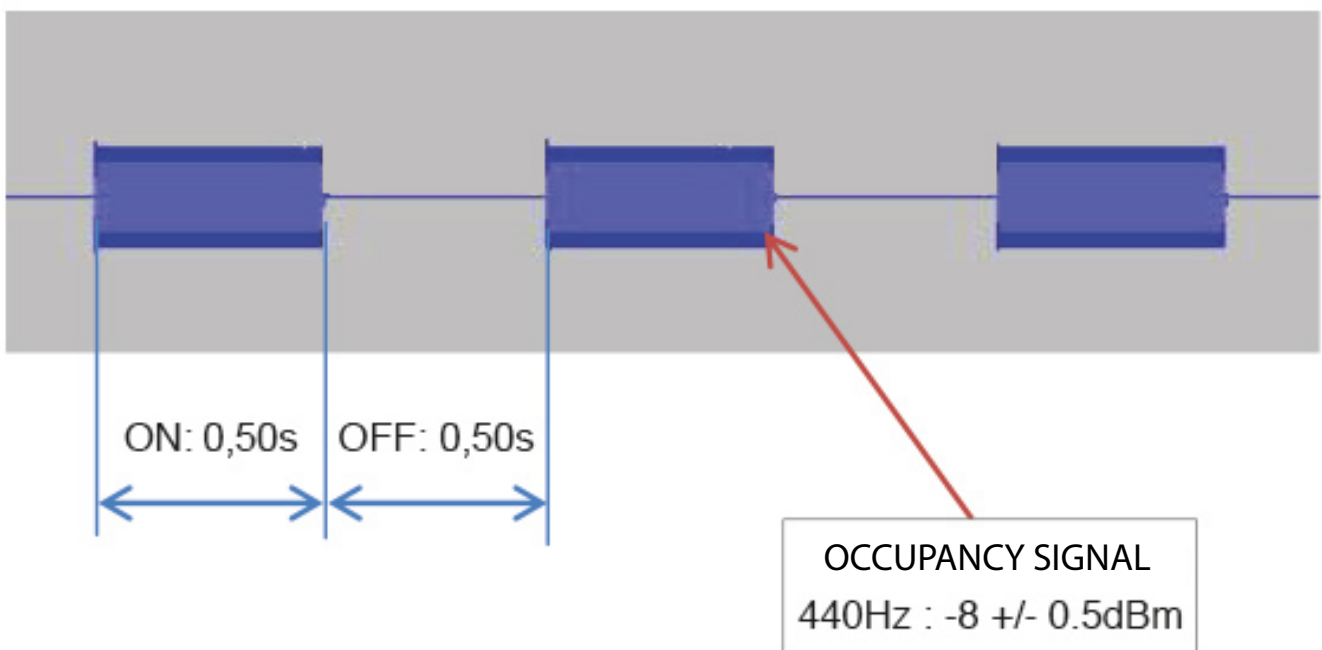

**ANEP BOX** emits a melody 10 seconds before the end of the programmed communication timer (see 7/8 page 24).

## 8.5 - Green button functions

### 1 - Technician presence» function



The green technician presence button informs the service center of the presence of a technician on the elevator.



Pressing the button triggers a «*Technician present*» voice announcement, followed by a call to send the information.

A second press triggers a voice announcement «*Technician departure*» followed by a call to send the information.

### 2 - End of alarm» function



If a user alarm is in progress, pressing the green button terminates the user alarm, and a voice announcement tells the technician that the alarm has ended (active discrimination if programmed).

## 9 - **BOX TX+ FUNCTIONS**

The **TX+** version of **ANEP BOX** includes all the functions of the **TX** version and adds :

- 1 - Voice synthesis on triggering of blocked user alarm,
- 2 - Alarm siren function (*HP in buzzer function*)
- 3 - The floor statement function,
- 4 - Taking into account the arrival and departure of the technician,
- 5 - A regular voice message reminding you of the technician's presence,
- 6 - The ability to broadcast a voice message after a cabin alarm has been triggered, until the alarm has been acknowledged by the technician,
- 7 - A «Cabin light» entrance,
- 8 - Monitoring elevator operation (*remote monitoring*)

### 9.1 - Voice synthesis on blocked user alarm

To reassure users trapped in the cabin, the **ANEP BOX TX+** broadcasts a message by synthesized voice, once the «trapped user» alarm has been acknowledged and the elevator alarm button has been pressed.

### 9.2 - Alarm siren

The «alarm siren» function integrated in **ANEP BOX TX+** is activated after an alarm has been triggered in two situations:

- 1 - When the phone call is unsuccessful, at the end of the call attempt cycle.
- 2 - Immediately when the alarm is triggered after detecting a drop in telephone line voltage (voltage below 28 Volts), which indicates that either the telephone line is faulty, or that another BOX using the same telephone line is calling.

The activation time is 6 seconds and the selected loudspeaker is the one integrated in the **ANEP BOX TX+** (cab roof).

**This function requires a 12Vdc power supply (type ALIM-CONTROL 2).**

#### 9.2.1 - Alarm siren on alarm button

The siren can be activated each time the cabin alarm button is pressed.

Whether the alarm is discriminated or not, the acknowledgement of the cabin alarm can be signaled by the built-in siren goi

- In programming mode **\*123**  
Enable siren function **#401#**  
Disable siren function **#402#**

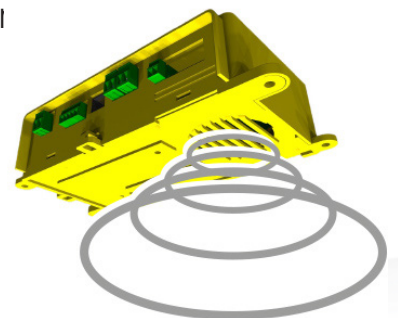

### 9.3 - BOX TX+ clock setting

- In programming mode **\*123**  
Press keys **#601 83 'hh' 'mm'** in succession,  
**ANEP BOX TX+** emits a «Gong»,
- Finish by pressing twice on **\***

(hh and mm represent tens of hours, hours, tens of minutes and minutes)

Examples : For a setting at 3:48 p.m. => **#601 83 15 48**  
For a 7:30 a.m. setting => **#601 83 07 30**  
For a 9:05 a.m. setting => **#601 83 09 05**

#### 9.3.2 - Local time display

- In programming mode **\*123**  
Press the **# 602 83 #**  
**ANEP BOX TX+** announces the time in **4** digits
- Finish by pressing **\***

Example : 12h09 => «*ONE*», «*TWO*», «*ZERO*», «*NINE*» will be announced

### 9.4 - Floor statement

**ANEP BOX TX+** includes the option of announcing floors when doors open.

This function requires a 12Vdc power supply (**ALIM-CONTROL II** type).  
Level-based statements can be programmed and verified either locally or remotely via ANEPCenter®.

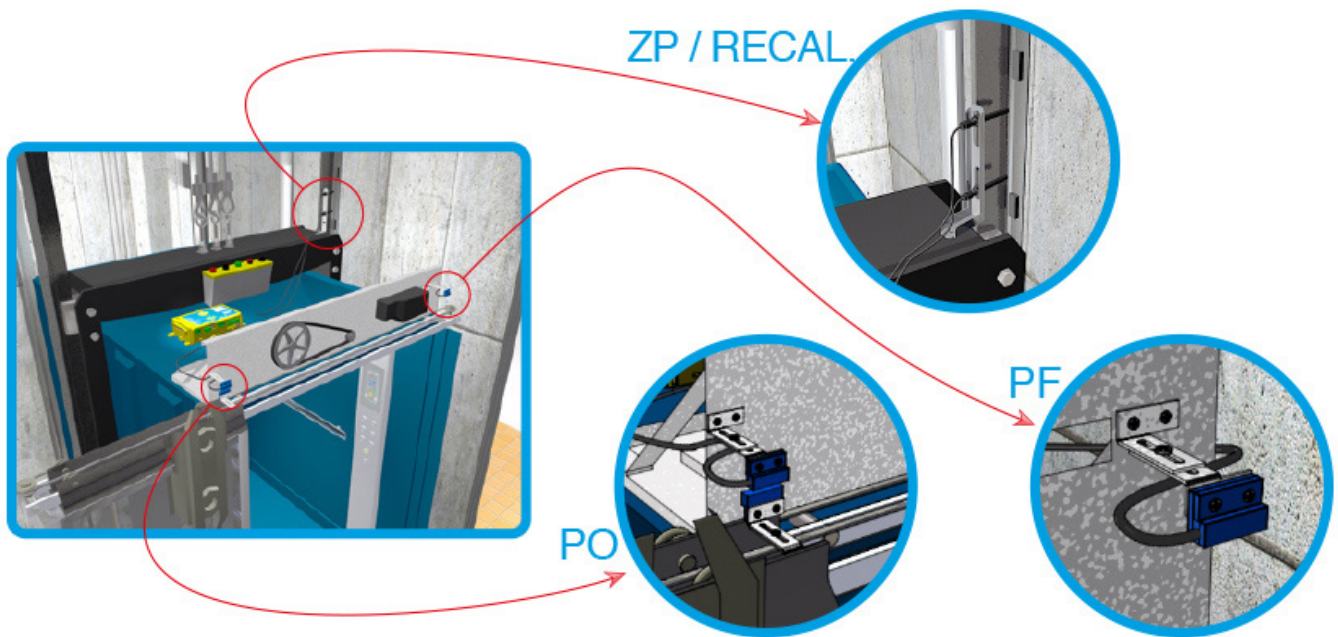

### 9.4.1 - Statement validation

- In programming mode **\*123**  
Press **#603** in succession
- Press the «#» key to validate  
The device emits a melody



The floor announcement at door opening and the message announcing door closure will be broadcast from 8 a.m. to 8 p.m. or permanently.

### 9.4.2 - Devalidation of statements

- In programming mode **\*123**  
Press **#604** in succession
- Press the «#» key to validate  
The device emits a melody



The floor statement and the message announcing door closure are not validated.

### 9.4.3 - Level programming via keypad

By default, floor statements for each level are stored in the **BOX TX+**.

In special cases, the position of the announcements can be modified to adapt the statements to the elevator.

The installer can modify the predefined position of the announcements (from 1 to 39).

Before starting programming, fill in a table (next page) with the references of the announcements to be made for each level.

To program a level the sequence is: **#601 «n» # «a» #**

«n» is **the level**, «a» is the **ad reference**..

These values range from **1** to **39** inclusive.

<b>Default ads</b>	
Level	Ads
<b>39</b>	31st floor
<b>38</b>	30th floor
<b>37</b>	29th floor
<b>36</b>	28th floor
<b>35</b>	27th floor
<b>34</b>	26th floor
<b>33</b>	25th floor
<b>32</b>	24th floor
<b>31</b>	23rd floor
<b>30</b>	22nd floor
<b>29</b>	21st floor
<b>28</b>	20th floor
<b>27</b>	19th floor
<b>26</b>	18th floor
<b>25</b>	17th floor
<b>24</b>	16th floor
<b>23</b>	15th floor
<b>22</b>	14th floor
<b>21</b>	13th floor
<b>20</b>	12th floor
<b>19</b>	11th floor
<b>18</b>	10th floor
<b>17</b>	9th floor
<b>16</b>	8th floor
<b>15</b>	7th floor
<b>14</b>	6th floor
<b>13</b>	5th floor
<b>12</b>	4th floor
<b>11</b>	3rd floor
<b>10</b>	2nd floor
<b>9</b>	1st floor
<b>8</b>	Ground floor
<b>7</b>	1st basement
<b>6</b>	2nd basement
<b>5</b>	3rd basement
<b>4</b>	4th basement
<b>3</b>	5th basement
<b>2</b>	6th basement
<b>1</b>	7th basement

<b>Editing ads</b>	
Level	Ad ref. to be programmed
<b>39</b>	
<b>38</b>	
<b>37</b>	
<b>36</b>	
<b>35</b>	
<b>34</b>	
<b>33</b>	
<b>32</b>	
<b>31</b>	
<b>30</b>	
<b>29</b>	
<b>28</b>	
<b>27</b>	
<b>26</b>	
<b>25</b>	
<b>24</b>	
<b>23</b>	
<b>22</b>	
<b>21</b>	
<b>20</b>	
<b>19</b>	
<b>18</b>	
<b>17</b>	
<b>16</b>	
<b>15</b>	
<b>14</b>	
<b>13</b>	
<b>12</b>	
<b>11</b>	
<b>10</b>	
<b>9</b>	
<b>8</b>	
<b>7</b>	
<b>6</b>	
<b>5</b>	
<b>4</b>	
<b>3</b>	
<b>2</b>	
<b>1</b>	

#### 9.4.4 - Broadcasting between 8 a.m. and 8 p.m,

- In programming mode **\*123**  
Press **#602 81** in succession  
Validate with **#**, the synthesis emits a «gong».  
Finish by pressing twice on the **\***

Note: The **ANEP BOX TX+** clock must be programmed beforehand by triggering a cyclic call.

#### 9.4.5 - Indication of floor announcement period

As soon as you enter programming mode, the green/yellow LEDs indicate the period for broadcasting floor announcements.

- Green light on: Floor announcements broadcast between 8 a.m. and 8 p.m.
- Yellow light on: Floor announcements broadcast 24 hours a day
- No LED on: Floor announcements not validated

### 10 - SERVICE VOICE / ALARM ACKNOWLEDGEMENT

After a cabin alarm has been triggered, an «Alarm in progress» is stored until the alarm acknowledge button is pressed during the technician's visit.

**ANEP BOX TX+** provides the option of announcing «Alarm in progress» and «Technician arrival» in the cab each time a door is closed on the main level (basic ground floor).

These service announcements are broadcast during the same period as the floor announcements (see floor announcement programming).

#### 10.1 - Validation of «Alarm in Progress» & «Technician Arrival» announcements

- In programming mode **\*123**  
Press **#605#** in succession

#### 10.2 - Disabling of «Alarm in progress» & «Technician arrival» announcements

- In programming mode **\*123**  
Press **#606#** in succession

The «Technician arrival» announcement is no longer played automatically while the technician is present, but remains valid when the Technician button is pressed.

#### 10.3 - Cabin alarm acknowledgement

If a cabin alarm is in progress, press the Technician button. It triggers the «End of alarm» announcement and deletes the «Alarm in progress» memory.



## 11 - SPEAKER AND MICROPHONE TEST

This test is launched :

- At the time of the periodic call, **ONLY IF** a **MIDIS** Plastron or a **BOX BA MAX** or **mini-GHP** is connected to the **BOX** (does not work with a remote microphone).
- Or on a call from the BOX by an operator to remove any doubt.

### 11.1 - Periodic «call test»

The test consists in emitting a 1 kHz frequency for 4 seconds into the loudspeaker, collecting it in the microphone and analyzing the signal received. If the signal is not correctly received, a new test is performed.

In the event of an «HP / Microphone» fault, an in-cab alarm is triggered, followed by activation of the BOX's built-in siren to warn of the malfunction, and then the normal call procedure.

### 11.2 - Test on request operator

It is possible to remotely check whether the loudspeaker/micro-cabinet is working properly. During the remote test, either the faceplate loudspeaker is tested, or the BOX's built-in loudspeaker is tested in the absence of a faceplate.

The test consists in transmitting a 1 kHz frequency for 4 seconds into the loudspeaker, collecting it in the microphone and sending it over the line to the communicating operator.

The sequence is as follows:

- Dial the number of the BOX telephone line

If only one **ANEP BOX TX+** is connected to the telephone line :

- Wait for the BOX to pick up.
- Then wait 3 seconds until a «**beep**» is heard in the phone.

→ Press key **6** on the phone, the 1kHz frequency should be audible.

If several **ANEP BOX TX+** are on the same telephone line, (*see diagram on page 17*) each BOX have different module numbers (**1**: master BOX, **2 to 8**: secondary BOXes) and only the master BOX picks up initially:

- Wait for the master BOX to go off-hook.
- Then wait 3 seconds until a «**beep**» is heard in the phone.
- If the test is intended for this BOX, press key **6** on the telephone, the 1kHz frequency should be heard.
- If the test is intended for a secondary BOX, immediately after the «**BEEP**», dial a 2-digit code to select the desired BOX. The 1st digit is the secondary BOX number (from 2 to 8) and the 2nd digit will be «**1**» for this application.
- Wait about **5 seconds** for a new «**beep**» to be heard in the phone.

→ Press key **6** on the telephone, a frequency of 1kHz should be heard.

## 12 - PRESENTATION OF THE TX+ VERSION

The **ANEP BOX TX+** product incorporates a method for monitoring elevator operation, enabling information to be sent remotely (elevator or product malfunctions) via the telephone network (wired or GSM).  
(elevator or product malfunctions) remotely via the telephone network (wired or GSM).

Operation of the **ANEP BOX TX+** «elevator monitoring» section requires a number of pre-settings (manual or automatic) prior to operation.

As the elevator monitoring results depend directly on the programming of the **ANEP BOX TX+**, it is important that the various paragraphs of the commissioning procedure are fully understood by the technician performing the commissioning.

### IMPORTANT :

Before commissioning the **ANEP BOX TX+**, it is essential to wire inputs E1 to E4 as shown on page 6, as these 4 inputs are used to control elevator operation (car position & door position).

In order to control the Up & Down travel limits, it is necessary **to add** the 2 magnets of 5 cm at the extremes.

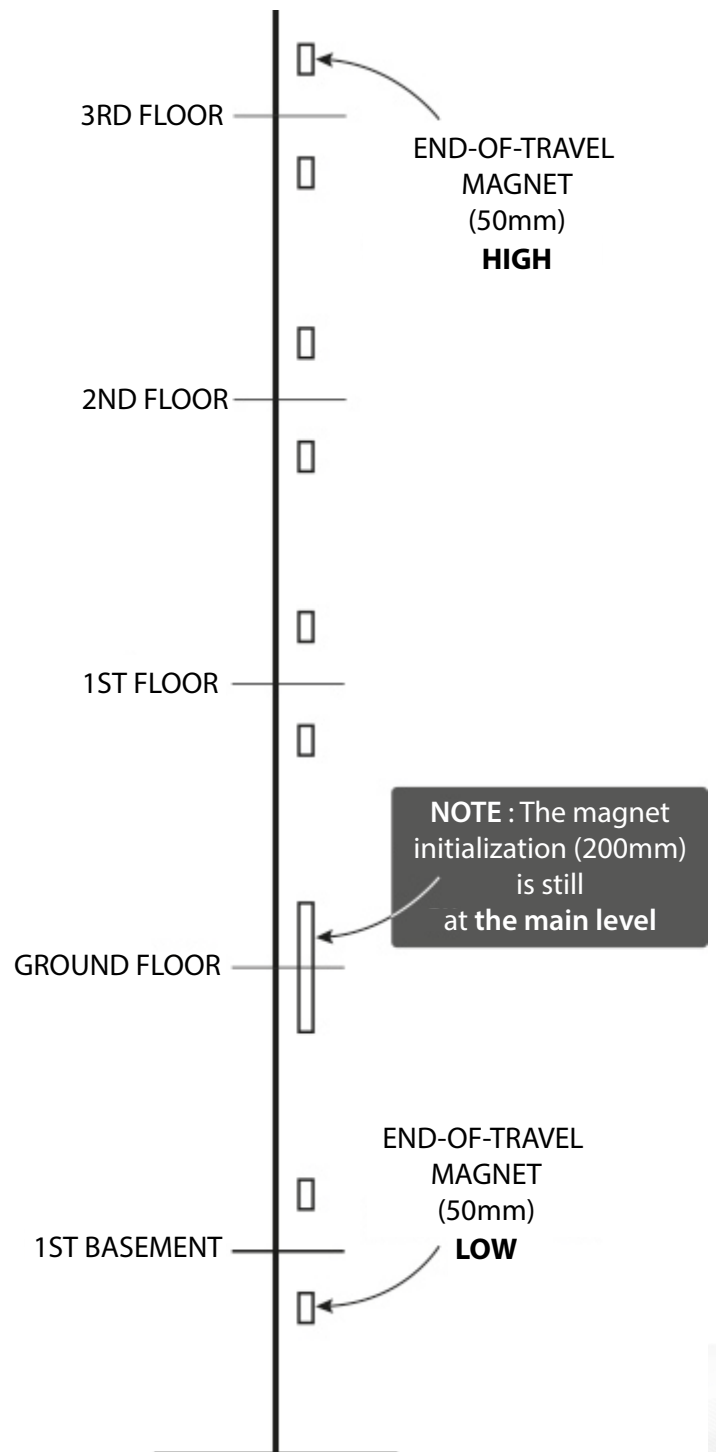

## 12.1 - Elevator monitoring

### 12.1.1 - Validation of elevator operation monitoring mode

- In programming mode **\*123**  
Confirm monitoring mode by dialing **#701#**  
Disable monitoring mode dial sequence **#702#**

Monitoring mode control

Using function **#703#**, the **ANEP BOX TX+** announces :

«*Remote monitoring enabled*» or «*Remote monitoring not enabled*».

### 12.1.2 - Learning procedure

Shaft learning varies according to the type of elevator door.

- In programming mode **\*123**

For :

- **Automatic doors: dial sequence #602 71 #**

- **Swing doors: dial sequence #602 72 #**

**ANEP BOX TX+** announces «*Validated*»

**ANEP BOX TX+** allows *4 minutes* to start the learning phase from the lowest level.

To exit programming mode, press « **\*** » twice for all **TX+** mode settings.

### 12.1.3 - Sheath learning launch

Training requires the presence of the technician in the cabin to move the elevator.

- 1 => Activate learning mode (Section 13.1.2),
- 2 => Set cabin to lowest level,
- 3 => Wait for the elevator to park normally (machine at rest),
- 4 => Trigger learning by pressing the cabin alarm button,  
The voice synthesis announces «Departure» in the cabin,
- 5 => Press the topmost order button,
- 6 => ANEP BOX triggers a «*Gong*» at the top end of cabin door opening
- 7 => Press the extreme down button,
- 8 => Bottom: **ANEP-BOX TX+** announces «*Remote monitoring enabled*» when the doors are opened.

**ANEP BOX TX+** informs the technician of an error during the learning phase by voice synthesis in the cabin:

- «*Inverted magnetic sensors*» : Reversing up/down impellers.
- «*No DO*» : No detection of door opening 10s after arrival.
- «*No DC*» : Move without cabin door closed after 4 levels.
- «*Magnet error*» : Incorrect information between upstroke and downstroke.

Values initialized during training :

- Run too long: measured run time (max) + 4 seconds
- Integrator: measured stroke time (max) + 14 seconds
- Maximum time between two levels (longest run between 2 levels)
- Position of highest floor (No. of levels above reference floor)
- Position of lowest floor (No. of levels below reference floor)

### 12.2 - Event validation (Faults/Malfunctions)

Each event analyzed by **ANEP BOX TX+** can be enabled or disabled..

**NO EVENT IS VALIDATED AT THE FACTORY, PROGRAMMING BEING LEFT TO THE DISCRETION OF THE TECHNICIAN.**

#### 12.2.1 - Event validation sequence :

- In programming mode **\*123**  
Dial the sequence **#601 4 nn #**, «**nn**» is the fault reference to be validated.  
At the end of the sequence, **ANEP BOX TX+** announces «*Validated*»..

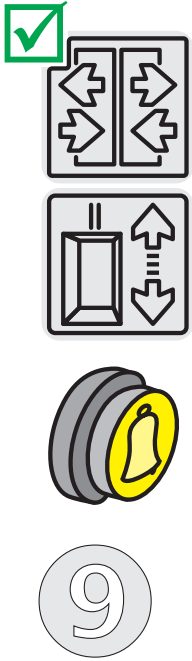

Exemple : to validate reference **8**, dial **#601 4 8 #**.

# LEARNING BOX TX+



- A hand holding a blue and yellow card. A red circle highlights the top of the card.

\* 123  
# 602 71 #  
or  
# 602 72 #

 AUTOMATIC DOORS  
 SWING DOORS
- An icon of an elevator cabin with a hand pointing to the bottom floor button. A green checkmark is in the top left corner.

Set cabin to lowest level
- An icon of an elevator cabin with a green dot on the right side. A green checkmark is in the top left corner.

Wait for the elevator to come to rest,
- A hand inserting a coin into a slot. A speaker icon and the text «DEPARTURE» are to the right.
- A hand pressing the topmost button on a vertical stack of buttons.
- An icon of an elevator cabin with a green checkmark in the top left corner. A speaker icon and the text «GONG» are to the right.
- A hand pressing the bottom button on a vertical stack of buttons. The text «REMOTE MONITORING ENABLED» is to the right.
- An icon of an elevator cabin with a green checkmark in the top left corner. A speaker icon and the text «REMOTE MONITORING ENABLED» are to the right.

## 12.2.2 - Fault inhibition sequence :

→ In programming mode **\*123**

**#601 5 nn #** «nn» is the event reference to be validated.

At the end of the sequence, **ANEP BOX TX+** announces «Not validated».

Exemple : to disable reference **8**, dial **#601 5 8 #**.

## 12.2.3 - Event references

Fault / Event			
Ref.	Type	Wording	Information
<b>1</b>	<b>Fault</b>	Cabin blocked between floors	Above learning value
<b>2</b>	<b>Fault</b>	Door operator *	* Upstairs, no cabin door opening
<b>3</b>	<b>Fault</b>	Door not opened on arrival	No cabin door opening on arrival
<b>4</b>	<b>Fault</b>	Door jammed open **	** Door remains open
<b>5</b>	<b>Fault</b>	Start-up *	* Upstairs, cabin door closed, no movement
<b>6</b>	<b>Fault</b>	Door cycle	More than 15 cycles on the floor without moving
<b>7</b>	<b>Fault</b>	Race too long	Above learning value
<b>8</b>	<b>Anomaly</b>	Missing magnetic sensor	A single sensor is detected (cab position)
<b>9</b>	<b>Anomaly</b>	Synchronization magnet missing	Change to level 0 without detection of readjustment magnet
<b>10</b>	<b>Anomaly</b>	No magnet on closed door	Cabin displacement without closed cabin door
<b>11</b>	<b>Fault</b>	Door closing sequence	Door closes without reaching the end of closing
<b>12</b>	<b>Event</b>	Long technician presence (LTP)	Preset at 2 hours
<b>13</b>	<b>Fault</b>	Inactivity	No elevator motion detected
<b>14</b>	<b>Event</b>	Shutdown	Equipment taken out of service by technician
<b>15</b>	<b>Fault</b>	Limit switch	Elevator in upper or lower limit position

**\* Swing door only**

**\*\* Automatic door only**

It is possible to validate several events at the same time.

No need to dial sequence #601 each time..

Exemple : to validate events **1, 2, 3, 8, 15** do the sequence :

**#601 41# 42# 43# 48# 415#**

**Note:** The end of the fault is automatically detected and sent after the elevator has moved normally; only one fault can occur at a time. **In the event of a reset without a door opening, do not program fault 3.**

## 12.2.4 – Reading fault validation

- In programming mode **\*123**  
Dial the sequence **#601 6 'nn' #** where «nn» is the number of the fault to be read  
**ANEP BOX TX+** announces «*Validated*» or «*Not validated*».  
Press **\*** twice to exit programming mode

**Caution:** only one value can be read at a time. Exit programming mode and return to read another value.

The number of faults is limited to 4 per day, to avoid excessive information on repetitive faults.

**NOTE :** **The inactivity fault is the only major fault that can be used to ensure that the elevator is working properly in the event of any type of failure.**

## 12.2.5 – Door type reading

- In programming mode **\*123**  
Dial sequence **#601 7#**  
**ANEP BOX TX+** «*Automatic*» or «*Hinged*» announcement  
Press **\*** twice to exit programming mode

This is an important check, as it indicates that the learning procedure has been carried out correctly.

## 12.2.6 – Programming inactivity time

The notion of inactivity is a period of time during which the elevator is not moving.

Programming of the time after which the fault will be transmitted (number of hours of inactivity)

**IMPORTANT :** **ANEP BOX TX+** only checks for elevator inactivity between 8:00am and 8:00pm.

- In programming mode **\*123**  
Dial sequence **#602 6 n #** «n» being the number of hours from 0 to 7  
Press **\*** twice to exit programming mode

To disable the «Inactivity» fault, the value **0 hour** must be programmed.

## 12.2.7 – Technical fault filtering

It is possible to delay the triggering of technical faults,

- In programming mode **\*123**  
Dial sequence **#309 xx #**  
*xx is the filter delay value.*

*This value can be programmed from 0 to 99, where the step size is 1 min (99 = 140 min).*

Press **\*** twice to exit programming mode



## 12.3 - Commissioning checks

### 12.3.1 - Door information control

Particular care must be taken when setting the DO/DC sensors, to ensure that the contacts remain in the desired state at the end of opening and closing. Ex: Hard mechanical or cabin door release at rest.

### 12.3.2 - Monitoring control

How to check the **ANEP BOX TX+** elevator monitoring functions

#### 12.3.2.1 - Check surveillance mode validation:

- Enable monitoring function **#703#**  
**ANEP BOX TX+** announces «*VALIDATED*»

If this is not the case, please refer to chapter 13.1- Lift monitoring.

Check door type selection.

Function **#601 7 #**, **ANEP BOX TX+** announces «*Automatic*» ou «*Hinged*»

If the choice does not match, refer to chapter 13.1- Lift monitoring

#### 12.3.2.2 - Check synthesizer operation

- There must be no floor statements while the cabin is moving, otherwise check the PF (cabin door close end) contact setting.
- Correspondence of floor statements when opening doors on floors (statement settings see chapter 10.4 FLOOR STATEMENTS)
- When the door is open, there must be no «door closed» message before the door begins to close. (cabin door open contact setting PO)
- When the elevator arrives at the floor, there must be no gong before the door begins to open (set car door closed contact PF).

#### 12.3.2.3 - Checking failure transfer

To perform the following checks, press the green button on the BOX to confirm that the technician is «not present». The BOX must then announce «*Technician departure*».

Leave the elevator in normal parking mode for **7 minutes**; no calls should be triggered (listening for DATA transfers).

**Fault tests:** Block the cabin between floors and wait **7 minutes**, ANEP BOX must call and send the «cabin blocked between floors» fault, check with the remote supervisor that the event has occurred. After two displacements, the end-of-fault call must be sent.

**Please note call limitation (4 faults per day), see section 13.2.1 Event validation.**



## Entering and exiting programming mode

- \* + < Access Code > Switch to settings mode
- \* Exit programming mode

### **#0...**

### Setting

- #001# Reset settings and Tel no.
- #002...# New Access Code

### **#1...**

### Tel. number

- #101...# Main phone number for voice call
- #102...# Emergency phone number for voice call
- #104...# Tel. number of the receiving centre to transmit data after the call
- #105...# Call Tel number **Cyclic test**
- #106...# Internet tel no. (ANEPanywhere)

### **#2...**

### Communication

- #201...# Call duration (1 to 99 in mn)
- #202# Operator call acknowledgement function enabled
- #203# Operator call acknowledgement function not validated
- #204# «Full duplex» mode enable
- #205# «Full duplex» mode disabling
- #206# Enable «Dual call» mode
- #207# Disabling «Double call» mode
- #208# 12V control function enabled
- #209# 12V control function not enabled

### **#3...**

### Configuration

- #301...# Cyclic test frequency (1, 2 or 3 days)
- #302...# Alarm input acknowledgement delay (10 to 63 in 1/10 s)
- #303...# Module address (from 1 to 8)
- #304...# Cabin light input delay (0 to 99 min)
- #...# Landing door entry timer and reset memo BOX SECU
- #306...# Input info type Cabin light
- #307# No cabin alarm discrimination
- #308# Discrimination of cabin alarm processed by BOX
- #309# Discrimination of cabin alarm processed by external equipment (ex: BOX-DISCRI)

### 13 - KEYBOARD PROGRAMMING TABLE (CONTINUED)

#### #4...

#### Configuration

#401#	Enable siren function
#402#	Disable siren function
#403#	AUTOCOM mode
#404#	Standard mode
#405#	Enable GSM mode
#406#	GSM Mode disabling
#407#	Microphone gain adjustment (For <b>BOX-M</b> intercom)
#408#	Loudspeaker gain setting (For <b>BOX-M</b> intercom)
#417#	Yellow/Green LED management validation to 2003 standards (default)
#418#	Validation of Yellow/Green indicator management to <b>2022</b> standards
#419#	Validation of yellow/green LED management to <b>2022</b> standards, with yellow LED extinguished when the BOX is no longer in communication.

#### #6...

#### Floor statements / remote monitoring

#601 n# a#	If «n» and «a» are between 1 and 39: programming a floor statement If «n» and «a» are between 1 and 39: programming a floor statement
#601 83 ...#	Time setting (hours and minutes)
#601 4 nn#	Fault validation sequence
#601 5 nn#	Fault inhibition sequence
#601 7#	Door type reading
#601 nn#	Reading fault programming
#602 n#	If «n» is between 1 and 39: speech synthesis broadcasts a floor statement
#602 41#	Manual shutdown of elevator
#602 5 n#	Programming of maximum number of levels («nn» from 0 to 20)
#602 6 n#	Programming of inactivity time («n» from 0 to 7)
#602 71#	Automatic doors
#602 72#	Swing doors
#602 81#	Limit floor and message announcements from 8am to 8pm
#602 82#	Floor and message statements 24/24h
#602 83#	Time reading
#602 9n#	Synthesis sound level setting («n» from 1 to 8)
#603#	Floor statement function enabled
#604#	Floor statement function not validated
#605#	Alarm in progress» and «Technician arrival» messages enabled
#606#	Alarm in progress» and «Technician arrival» messages not validated
#607#	Forces MIDIS phony detection
#608#	Enables automatic detection by BOX TX+ LINK

#### #7...

#### Remote monitoring

#701#	Remote monitoring validated
#702#	Remote monitoring not validated
#703#	Remote monitoring validation status readout
#704#	Send Up/Down function enabled (with BOX-ENVOIS)
#705#	Send Up/Down function not enabled (with BOX-ENVOIS) by default
#706#	End of automatic alarm enabled
#707#	End of automatic alarm not validated

### 13 - KEYBOARD PROGRAMMING TABLE (CONTINUED)

#9...	<i><b>Extension configuration</b></i>
#901#	Cyclic test N°2 activated (if MEM 106 is programmed)
#902#	Cyclic test N°2 deactivated

### 14 - KEYBOARD PROGRAMMING TABLE WITH BOX-INTENS (CONTINUED)

#### IF BOX-INTENS INSTALLED

(OPTIONAL)

(see also NOTICE BOX-INTENS)



#903#	Inactivity fault managed by day timer at any time.
#904#	Inactivity fault managed by day timer between 8 a.m. and 20h (8 p.m.) and night timer from 20h (8 p.m.) to 8 a.m.
#905 x#	Set <b>inactivity period DAY</b> => (no movement followed by door opening) «x» is the value in ½ hour or 1 hour of the period from 1 to 20 (8).

	<i>From BOX TX+ in versions <b>TPL 00-C</b> to <b>TPL 00-F</b></i>	<i>From BOX TX+ in version <b>TPL 00-G</b></i>
#905 1#	Daytime inactivity fault 0:30am	Daytime inactivity fault 1h00am
#905 2#	Daytime inactivity fault 1h00am	Daytime inactivity fault 2h00am
#905 3#	Daytime inactivity fault 1:30am	Daytime inactivity fault 3h00am
#905 4#	Daytime inactivity fault 2h00am	Daytime inactivity fault 4h00am
#905 5#	Daytime inactivity fault 2h30am	Daytime inactivity fault 5h00am
#905 6#	Daytime inactivity fault 3h00am	Daytime inactivity fault 6h00am
#905 7#	Daytime inactivity fault 3h30am	Daytime inactivity fault 7h00am
#905 8#	Daytime inactivity fault 4h00am	Daytime inactivity fault 8h00am
#905 9#	Daytime inactivity fault 4h30am	Daytime inactivity fault 9h00am
#905 10#	Daytime inactivity fault 5h00am	Daytime inactivity fault 10h00am
#905 11#	Daytime inactivity fault 5h30am	Daytime inactivity fault 11h00am
#905 12#	Daytime inactivity fault 6h00am	Daytime inactivity fault 12h00am
#905 13#	Daytime inactivity fault 6h30am	Daytime inactivity fault 13h00pm
#905 14#	Daytime inactivity fault 7h00am	Daytime inactivity fault 14h00pm
#905 15#	Daytime inactivity fault 7h30am	Daytime inactivity fault 15h00pm
#905 16#	Daytime inactivity fault 8h00am	Daytime inactivity fault 16h00pm
#905 17#	Daytime inactivity fault 8h30am	Daytime inactivity fault 17h00pm
#905 18#	Daytime inactivity fault 9h00am	Daytime inactivity fault 18h00pm
#905 19#	Daytime inactivity fault 9h30am	Daytime inactivity fault 19h00pm
#905 20#	Daytime inactivity fault 10h00am	Daytime inactivity fault 20h00pm



# NOTES

---

---

---

---

---

---

---

---

---

---

---

---

---

---

---

---

---

---

---

---

---

---

---

---

## NOTES

ANEP applies a method of continuous development, therefore, ANEP reserves the right to make changes and improvements to any product described in this document, without notice.

ANEP cannot under any circumstances be held liable for any loss of data, as well as any particular damage or incident, resulting from poor implementation or non-compliant use of the product.

The contents of this document are provided “as is”. No warranty of any form, express or implied, is made as to the accuracy, reliability, or content of the document.

ANEP reserves the right to revise this document or withdraw it at any time without notice..



Electrical equipment must be compulsorily recycled according to Directive n°2012/19/EU of 04/07/12 relating to waste electrical equipment and Electronic (WEEE)

### WARRANTY

This product is guaranteed for **3 years** from the date of invoicing of the product, with the exception of batteries and cells which are guaranteed for **6 months**.

However, this guarantee does not apply in the event of:

- Use that does not comply with the instructions in this manual.
- Deterioration from a cause external to the product (act of vandalism, fire, flood, storm, overvoltage...).
- Installation carried out by an unqualified installer not approved by ANEP.
- Modifications or repairs carried out by entities not approved by ANEP.
- Opening of the product by a non-ANEP approved person.

THE AFTER SALES SERVICE IS PROVIDED BY

**SAVTEL**

4 bis rue de Paris 94470 Boissy-Saint-Léger

Tél : +33 1 45 98 34 44



Website : [www.anepstore.com](http://www.anepstore.com)